

| Каталог продукции 2013 |

| Интерьерное освещение |



Уважаемые Дамы и Господа!

Более 15 лет ООО «Торговый Дом «Реал Керамика» импортирует на российский рынок сантехнику, керамическую плитку и керамогранит. В середине 2011 года в складскую программу нашей компании было включено интерьерное освещение из Польши.

Уже сегодня мы предлагаем осветительное оборудование торговых марок FAROS (Испания) и SCHAFFNER (Австрия). Продукция сегментирована по ценовому принципу.

Кроме интерьерного освещения мы предлагаем энергосберегающие лампы от одного из самых качественных производителей лампочек в КНР компании OPPLLE.

Представляю вашему вниманию каталог интерьерного освещения марок FAROS и SCHAFFNER 2013 года. Надеюсь, что эта продукция поможет нашим партнерам расширить товарные группы для привлечения большего количества покупателей, увеличить эффективность работы торговых точек и сократить логистические расходы.

Мы не ставим точку в формировании складской программы и уже в ближайшем будущем планируем удивить вас более расширенной программой от производителей Европы и КНР.

С уважением,
Генеральный директор
ООО «Торговый Дом «Реал Керамика»
Андрей Ситников.

ООО «Торговый Дом «Реал Керамика»

- Широкий ассортимент по трём взаимодополняющим направлениям – сантехника, плитка и интерьерное освещение;
- Только ликвидный ассортимент. Регулярное обновление и расширение ассортимента за счет новых, тщательно отобранных коллекций;
- Комплексная и профессиональная отгрузка с центрального склада в г. Балабаново Калужской области;
- Работа центрального склада с 8.00 до 22.00 по будням;
- Отгрузка от любого объема (от штуки);
- Железнодорожные и автомобильные поставки по России;
- Профессиональный менеджмент;
- Предоставление торгового оборудования;
- Постоянное наличие товара на складе;
- Помощь в формировании правильного ассортимента (учитывая многолетний опыт, сезонность и рейтинг коллекций);
- Помощь в оформлении экспозиций, шоу-румов;
- Обучение персонала (проведение семинаров, консультации по телефону и непосредственно в точках реализации);
- Проведение различных рекламных акций и другая рекламная поддержка;
- Оперативная работа с рекламациями;
- Гибкий индивидуальный подход к каждому покупателю. Создание наиболее выгодной для партнера схемы работы.
- Работа с заказами в режиме «реального времени» через оригинальный интернет-ресурс «Стол заказов».



**Faros | 4 - 32 |**

Испания

Adel	4
Luna	5
Poloma	6
Doris	7
Angelica	8
Beatriz	9
Chero	10
Rosa	11
Charlotte	12
Capris	14
Paola	16
Amali	17
Gracia	18
Leticia	20
Leonardo	22
Greta	23
Paris	24
Julia	24
Alicia	24
Perla	25
Geneva	25
Diamand	25
Bonita	26
Trini	27
Fusion	28
Sandra	29
Sandra II	30
Veronika	30
Luigi	30
Rico	31
Kruz	31
Letti	31
Ibbi	31
Juanna	32
Jordan	32

**Schaffner | 33 - 85 |**

Австрия

Bruno	33
Berta	34
Odri	35
Loren	36
Helena	37
Irma	38
Ilma	39
Luisa	40
Steffani	41
Ricardo	42
Henry	43
Brauni	44
Brigit	45
Nadin	46
Andrea	46
Gabriel	46
Gerda	47
Nicole	48
Franciska	49
Karlin	49
Larey	50
Isadora	50
Elsa	51
Margarita	52
Anika	53
Rafaella	53
Heddi	54
Lore	54
Leona	55
Marlis	55
Teresa	56
Anabel	56
Milena	57
Ella	57
Mila	58
Rebeka	58
Rud	59
Mad	59
Idan	59
Ils	59
Sofie	60
Sabina	61
Siggi	62
Minni	63
Klara	64

Emma	66
Hilda	67
Agna	68
Till	69
Bindi	70
Rozmari	71
Frida	72
Zara	73
Klaus	74
Ninelle	75
Roksana	76
Kleo	77
Hanna	78
Fiona	79
Christian	80
Lot	81
Jina	81
Artur	82
Karina	83
Linda	84
Lisa	84
Betti	85

Настольные и напольные светильники | 86 - 90 |

Австрия

1986/3T	86
1986/6F	86
2303/1F	87
2303/1T	87
2410/1F	88
2410/1T	88
2507/1T	89
2507/4F	89
2424/1F	90
2424/1T	90

**Opplle | 91 - 98 |**

Китай

MX435-Y40(YS)	91
MX3434-Y38(BQ)	91
MX3535-Y28(FZ)	91
MD400D-Y15*3 Radiance	92
MD550D-Y15*3 Radiance	92
MD550F-Y15*3 Elegant cone	92
MB549-Y24Z (Xingdong)	93
MX549-Y24 (Liangjing)	93
MX586-Y83 (KZLG)-Blue	93
MX300-Y22 (QY)-Blue	93
MX500-Y28+38(QY)-Blue/ Amber/Violet	93
MX1860-Y10	94
MX200-Y21 (XFB)	94
MX801-Y21 (XF)	94
MX803-Y21 (XY)	94
MX500-Y28+38(QBYB)	95
MX420-Y40(HY)	95
MX500-Y28+38(HY)	95
MX300-Y22(QB)	95
MX420-Y40(QB)	95
MX300-Y22(YW)	95
MX420-Y40(YW)	95
MD500-Y60-TSGH (Silver Gray)	96
MX500E-Y60-TSGH (Silver Gray)	96
Энергосберегающие лампы Opplle	97

Особенности полиграфии не позволяют передать цвета в полном соответствии с оригиналом.

ООО «Торговый Дом «Реал Керамика» не несет ответственность за возможные изменения производителями технических характеристик и артикулов товаров, указанных в данном каталоге, после его издания, и не отвечает за возникшие ошибки печати.

Faros				Shaffner						Настольные и напольные светильники	
Артикул	стр.	Артикул	стр.	Артикул	стр.	Артикул	стр.	Артикул	стр.	Артикул	стр.
0564/1	26	1948/5P	10	01211-3	68	2151/5P	60	8652-12	48		
0564/2	26	1948/8P	10	01211-5	68	2213-1	59	8652-9	48	Артикул	стр.
0564/3	26	1954/12C	5	01212-3	74	2215-1	59	8652-9LED	48	1986/3T	86
0564/4A	26	2180/6P	6	01212-4	74	2231/10C	70	8657-12	47	1986/6F	86
0564/4C	26	2266/2W	8	0488/1	34	2231/5C	70	8657-12LED	47	2303/1F	87
0712/1	31	2266/3P	8	0488/1W	34	2564/2W	61	8657-9	47	2303/1T	87
0717/2	17	2266/5P	8	0488/5A	34	2564/8P	61	8657-9LED	47	2410/1F	88
0717/6	17	2266/6P	8	0488/8	34	2656/5P	38	8660-12LED	49	2410/1T	88
0717/8	17	2266/8P	8	0594/1	33	2656/8P	38	8660-5LED	49	2424/1F	90
0718/1	32	2418/4C	7	0594/5	33	2656A/2W	38	8661-12	49	2424/1T	90
0718/2	32	2418/6P	7	0594/7	33	3025/1W	75	8661-15	49	2507/1T	89
0718/3B	32	2721-10	25	0628/2B	40	3025/3	75	8907-9	58	2507/4F	89
0720/2	20	2721-13	25	0629/5	40	3025/3(up)	75	90308C/3	73		
0720/4A	21	8003/1	14	0629/8	40	3025/5	75	90308C/6	73		
0720/4B	21	8003/2	14	0735/1	36	3025/5(up)	75	90374E/5	72		
0720/6B	21	8003/3	15	0735/4	36	3031/3	67	90374E/9	72	Oppl	
0720/8	20	8003/5	15	0735/5B	36	3031/5	67	90458/1	71	Артикул	стр.
0770/2	13	8003/8	14	0735/5D	36	3042/3P	83	90458/6	71	MB549-Y24Z (Xingdong)	93
0770/3	13	8023/10	18	0739/2	35	5220/7	51	90458/8	71	MD400D-Y15*3 Radiance	92
0770/5	12	8023/1B	19	0739/5A	35	5990/6	54	90630F/1	80	MD500-Y60-TSGH (Silver Gray)	96
0771/1	16	8023/2A	19	0739/5B	35	604/11	55	90630F/4	80	MD550D-Y15*3 Radiance	92
0771/3	16	8023/3	18	0749/2	39	6045-7LED	53	90630F/6	80	MD550F-Y15*3 Elegant cone	92
0771/5	16	8023/4	18	0749/5	39	6045-9LED	53	90741B/1	76	MX1860-Y10	94
0772/1	13	8023/6	19	0749/8	39	6058-12LED	50	90741B/3	76	MX200-Y21 (XFB)	94
0772/3	13	8023/8	19	0776/2	37	6058-7LED	50	90741B/5	76	MX300-Y22 (QB)	95
0775/1	11	8030/19	22	0776/3B	37	6085-12LED	53	90746C/1	65	MX300-Y22 (QY)-Blue	93
0775/2	11	8030/2	22	0776/5A	37	6085-3LED	53	90746C/2	64	MX300-Y22 (YW)	95
0775/5	11	8030/20	22	0777/2	42	6085-6LED	53	90746C/2	64	MX3434-Y38 (BQ)	91
0775/7	11	8030/3	22	0777/6	42	6091-13	46	90746C/3	65	MX3535-Y28 (FZ)	91
1000A/12P	9	8030/5	22	0777/8	42	6091-9	46	90746C/5	65	MX420-Y40 (HY)	95
1000A/8P	9	94116A/5	23	10036/1	43	668/7	85	90746C/6	64	MX420-Y40 (QB)	95
1021/1PC	27	94119/3	23	10036/4	43	668/9	85	90801A/1	78	MX420-Y40 (YW)	95
1021/2PC	27	96181/5	23	10036/6	43	668/11	85	90801A/3	78	MX435-Y40 (YS)	91
1021/3PC	27	9702-9	24	10036/8	43	7204-13	46	90801A/5	78	MX500-Y28+38 (QBYB)	95
1031/1	31	9707-7	25	10039/1	81	7204-9	46	90801A/6	78	MX500-Y28+38 (QY)-Blue/	
1032/1LA	31	9708-10	24	10039/4	81	7204-9LED	46	9561-13LED	51	Amber/Violet	93
1032/1LB	31	9709-9	25	10039/6	81	7204-13LED	46	96128A/1	77	MX500-Y28+38 (HY)	95
1032/1SA	31			10062/1	79	7225-9LED	52	96128A/3	77	MX500E-Y60-TSGH (Silver Gray)	96
1032/1SB	31			10062/3	79	7230-6LED	52	96128A/5	77	MX549-Y24 (Liangjing)	93
1065/1	30			10062/5	79	7230-9LED	52	96128A/8	77	MX586-Y83 (KZLG)-Blue	93
1068/1	29			10062/6	81	7501-15	50	96159B/1	84	MX801-Y21 (XF)	94
1068/2	30			10104/1	82	7501-18	50	96173/1	84	MX803-Y21 (XY)	94
1072/1	30			10104/3	82	8015/19	46	9618/13	57	Энергосберегающие лампы	
1080/2A	32			10104/5	82	8028/2	45	9618/8	57	Oppl	97
1080/2B	32			1097/6A	41	8028/4	45	9631/10	57		
1080/3	32			1097/8A	41	8028/6	45	9631/15	57		
1080/4	32			1176/1B	44	8085/3	62	9637/10	56		
1095/2	28			1212/1	44	8085/5	62	9652/10	56		
1095/3	28			1212/2	44	8088/1W	62	9667/10	58		
1101/1	28			2008-1	59	8097/1W	66	9667/16	58		
1754/8+8PC	4			2043-1	59	8097/3	66	9671/12	55		
1805L/1P	31			2047/5C	69	8097/5	66	9671/13	55		
1836/8+4P	5			2047/8C	69	8303/6	54	97024/1	63		
1948/1W	10			2151/1W	60	8303/9	54	97024/3	63		
1948/2W	10			2151/3P	60	863-9	24	97024/5	63		



1754/8+8PC
↑ 70, ↔ 90
16xG4 / 20W
💡 22 KB. M

ADEL

ADEL

1954/12C
↑ 31,2, ↔ 70
12xG4 / 20W
💡 18 кв. м



1836/8+4P
↑ 65, ↔ 95
12xG9 / 40 W
💡 18 кв. м



LUNA



2180/6P
↑ 80, ↔ 75,3
5xE14 / 40W + 1xGU10 / 50W
✱ 18 KB. M

POLOMA

2418/6P

↓ 40, ↔ 63

↓ 63, ↔ 63

6xG9 / 50W

💡 10 KB. M



2418/4C

↓ 14, ↔ 46

4xG9 / 40W

💡 6 KB. M



DORIS



2266/8P
 ↓ 120, ↔ 91
 8xE14 / 40W
 ⚡ 22 KB. M

2266/2W
 ↓ 27, ↔ 40
 2xE14 / 40W
 ⚡ 8 KB. M



2266/3P
 ↓ 52, ↔ 58,7
 3xE14 / 40W
 ⚡ 12 KB. M



2266/5P
 ↓ 120, ↔ 72
 5xE14 / 40W
 ⚡ 18 KB. M



2266/6P
 ↓ 120, ↔ 72
 6xE14 / 40W
 ⚡ 20 KB. M



ANGELICA



1000A/8P
↑ 120, ↔ 70,6
8xE14 / 40W
☀ 22 KB. M

1000A/12P
↑ 120, ↔ 70,6
12xE14 / 40W
☀ 27 KB. M



BEATRIZ

1948/8P
 ↑ 110, ↔ 80
 8xE14 / 40W
 ⚡ 22 KB. M



1948/1W
 ↑ 26, ↔ 13
 1xE14 / 40W
 ⚡ 4 KB. M



1948/2W
 ↑ 30, ↔ 37
 2xE14 / 40W
 ⚡ 8 KB. M

1948/5P
 ↑ 110, ↔ 67
 5x E14/40W
 ⚡ 18 KB. M



CHERO

ROSA

0775/7
↑ 40, ↔ 70
↑ 105, ↔ 70
7xG9 / 40W
💡 11 KB. M



0775/5
↑ 40, ↔ 62
↑ 105, ↔ 62
5xG9 / 40W
💡 9 KB. M



0775/1
↑ 14, ↔ 29,5
1xG9 / 40W
💡 2 KB. M



0775/2
↑ 14, ↔ 31
2xG9 / 40W
💡 3 KB. M



0770/5

↑ 40, ↔ 60

↑ 90, ↔ 60

5xG9 / 40W

⚡ 9 KB. M



CHARLOTTE

CHARLOTTE

0770/3
↓ 40, ↔ 52
↓ 90, ↔ 52
3xG9 / 40W
💡 5 KB. M



0772/1
↓ 17, ↔ 15
1xG9 / 40W
💡 2 KB. M



0770/2
↓ 12, ↔ 25
2xG9 / 40W
💡 3 KB. M



0772/3
↓ 43, ↔ 49
3xG9 / 40W
💡 5 KB. M





8003/8
 ↓ 40, ↔ 63
 8xG9 / 40W
 ⚡ 12 KB. M



8003/1
 ↓ 17, ↔ 11
 1xG9 / 40W
 ⚡ 2 KB. M

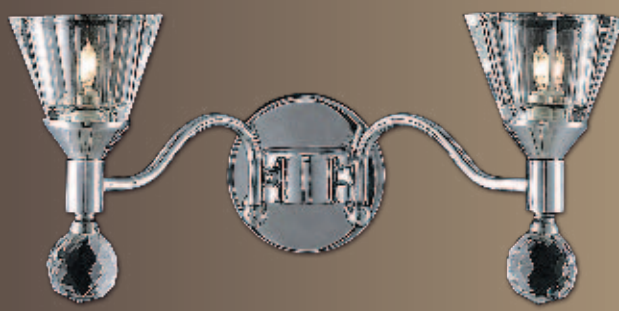

8003/2
 ↓ 17, ↔ 35
 2xG9 / 40W
 ⚡ 3 KB. M

CAPRIS



8003/5
↑ 40, ↔ 60
5xG9 / 40W
💡 9 KB. M



8003/3
↑ 40, ↔ 45
3xG9 / 40W
💡 5 KB. M

CAPRIS

0771/3
 ↓ 26, ↔ 48
 3xG9 / 40W
 ✨ 5 KB. M



PAOLA



0771/1
 ↓ 10, ↔ 25
 1xG9 / 40W
 ✨ 2 KB. M



0771/5
 ↓ 26, ↔ 55
 5xG9 / 40W
 ✨ 9 KB. M

0717/8
 ↓ 40, ↔ 70
 ↓ 90, ↔ 70
 8xG9 / 40W
 ⚡ 12 KB. M



AMALI

0717/6
 ↓ 40, ↔ 65
 ↓ 90, ↔ 65
 6xG9 / 40W
 ⚡ 10 KB. M



0717/2
 ↓ 15, ↔ 23
 2xG9 / 40W
 ⚡ 3 KB. M



8023/10
 ↓ 38, ↔ 65
 10xG9 / 40W
 ⚡ 16 KB. M



8023/3
 ↓ 38, ↔ 43
 3xG9 / 40W
 ⚡ 5 KB. M



8023/4
 ↓ 38, ↔ 50
 4xG9 / 40W
 ⚡ 6 KB. M

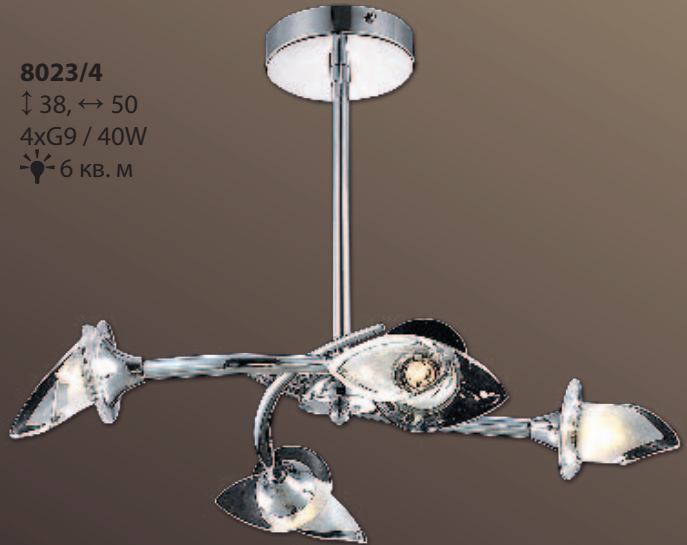

GRACIA

8023/8
 ↑ 38, ↔ 60
 8xG9 / 40W
 12 KB. M



8023/6
 ↑ 38, ↔ 60
 6xG9 / 40W
 10 KB. M

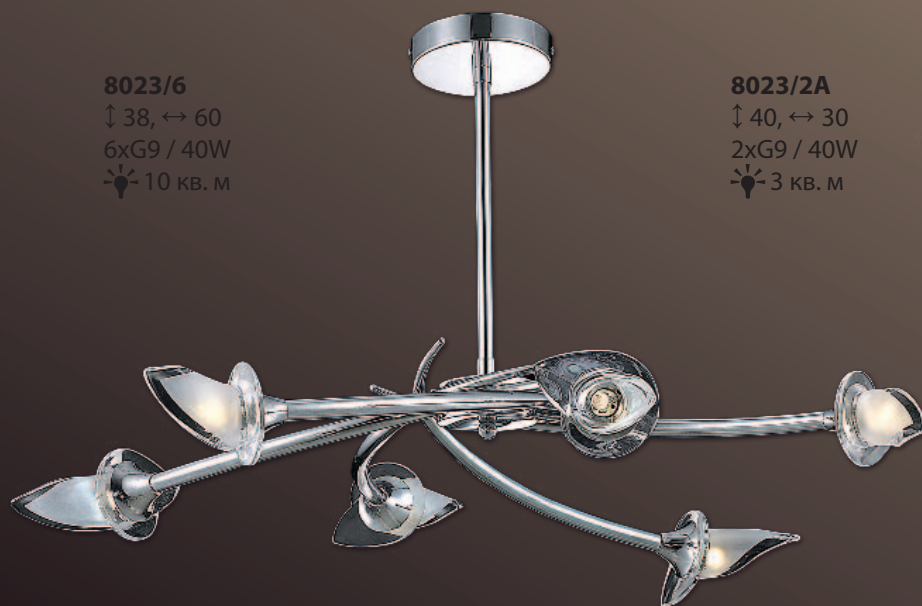

8023/2A
 ↑ 40, ↔ 30
 2xG9 / 40W
 3 KB. M



8023/1B
 ↑ 36, ↔ 10
 1xG9 / 40W
 2 KB. M



GRACIA

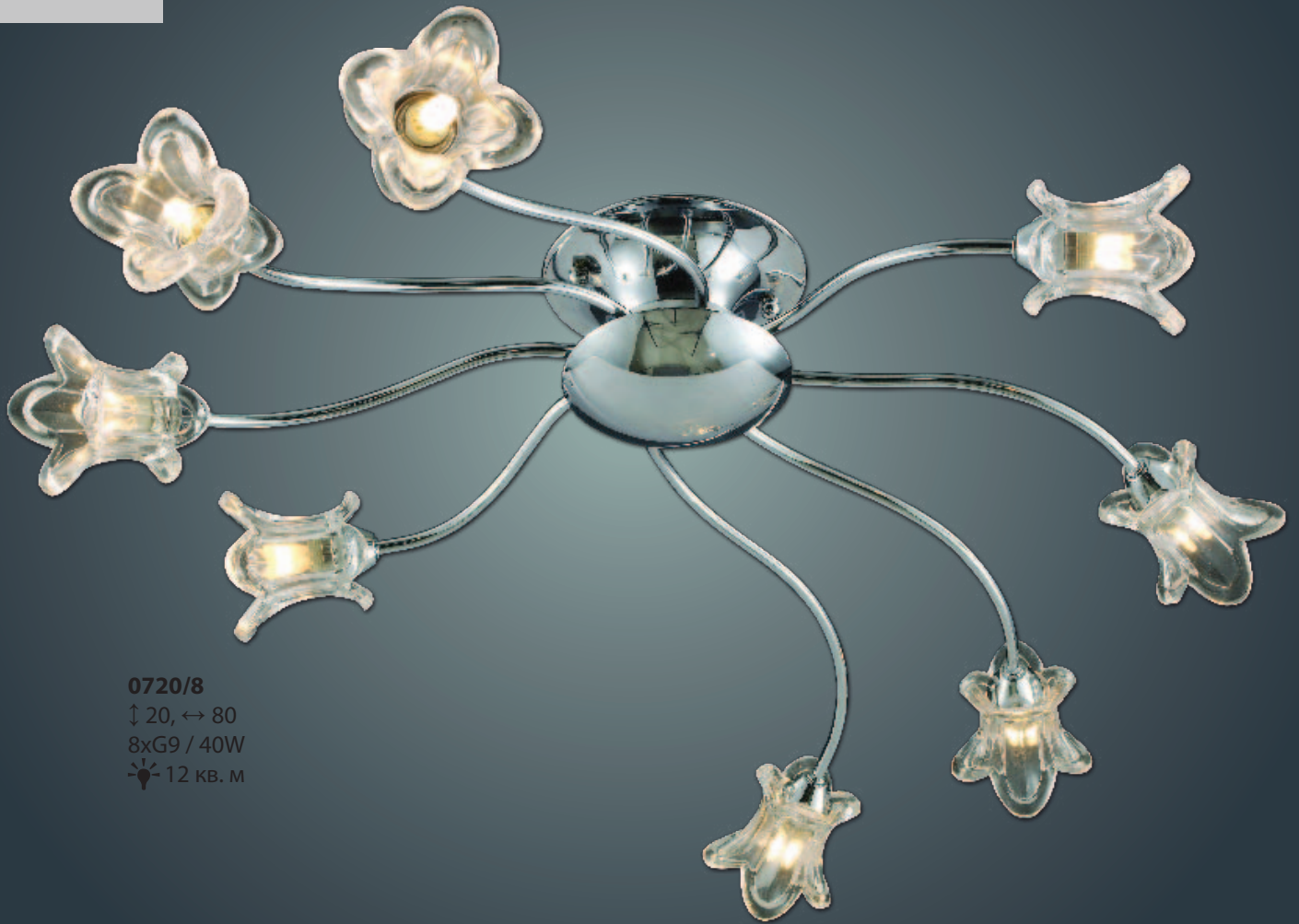

0720/8
↓ 20, ↔ 80
8xG9 / 40W
- 12 KB. M

LETICIA



0720/2
↓ 17, ↔ 28
2xG9 / 40W
- 3 KB. M

0720/4A
 ↓ 15, ↔ 63
 4xG9 / 40W
 - 13 кв. м



0720/4B
 ↓ 21, ↔ 72
 4xG9 / 40W
 - 6 кв. м



0720/6B
 ↓ 20, ↔ 80
 6xG9 / 40W
 - 10 кв. м

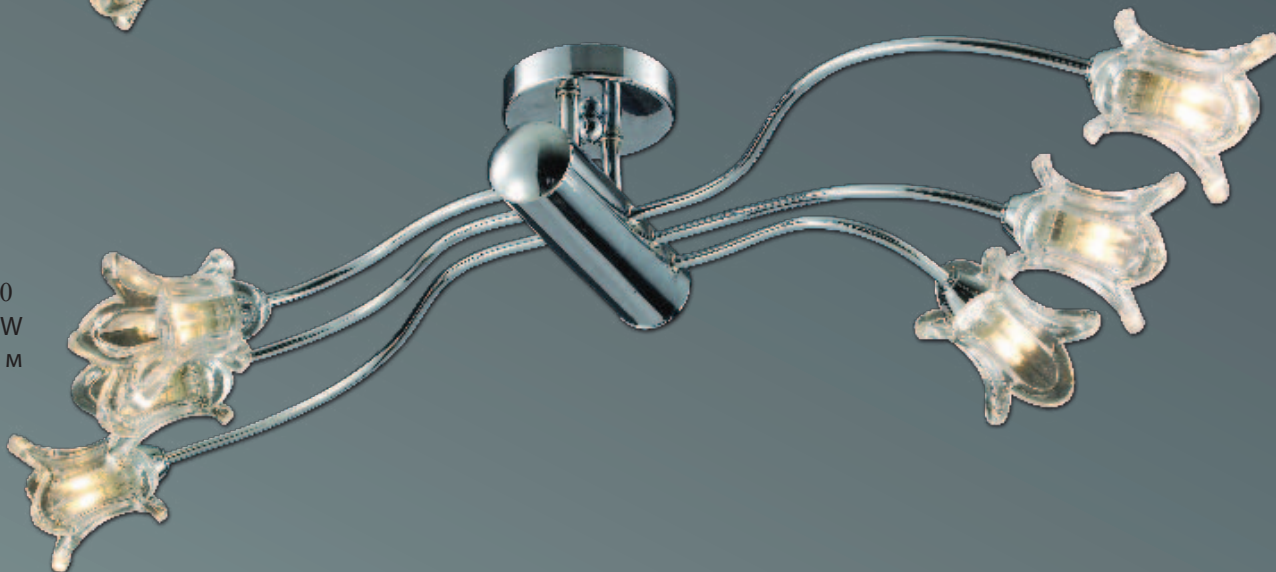

LETICIA

8030/20
 ↓ 40, ↔ 70
 ↓ 70, ↔ 70
 20xG4 / 10W
 ⚡ 27 KB. M



8030/3
 ↓ 16, ↔ 28
 3xG4 / 10W
 ⚡ 5 KB. M

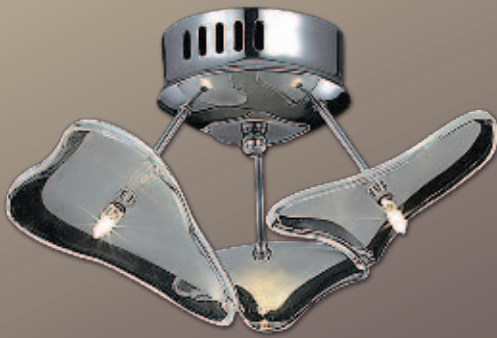

8030/19
 ↓ 35, ↔ 53
 19xG4 / 10W
 ⚡ 25 KB. M

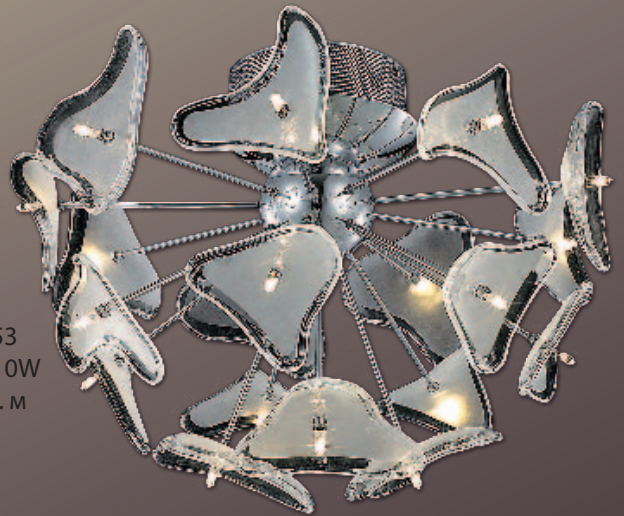

8030/2
 ↓ 12, ↔ 26
 2xG4 / 10W
 ⚡ 3 KB. M



8030/5
 ↓ 14, ↔ 63
 5xG4 / 10W
 ⚡ 9 KB. M



GRETA



96181/5

↑ 68, ↔ 48

5xE14 / 60W

☀ 18 KB. M



94119/3

↑ 39, ↔ 48

3xE14 / 60W

☀ 12 KB. M



94116A/5

↑ 32, ↔ 45

5xE14 / 60W

☀ 18 KB. M

9708-10
 ↑ 65, ↔ 50
 10xG4 / 20W
 ⚡ 16 KB. M



863-9
 ↑ 45, ↔ 55
 9xG4 / 20W
 ⚡ 14 KB. M



9702-9
 ↑ 35, ↔ 85
 9xG4 / 20W
 ⚡ 14 KB. M



JULIA

ALICIA

PERLA



9709-9
↑ 75, ↔ 50
9xG4 / 20W
💡 14 KB. M



9707-7
↑ 60, ↔ 55
7xG4 / 20W
💡 11 KB. M



2721-10
↑ 120, ↔ 60
10xG4 / 20W
💡 16 KB. M

2721-13
↑ 130, ↔ 70
13xG4 / 20W
💡 19 KB. M

GENEVA

DIAMAND





0564/4A
 ↑ 11, ↔ 34
 4xG9 / 40W
 ⚡ 6 KB. M



0564/2
 ↑ 36, ↔ 52
 2xG9 / 40W
 ⚡ 3 KB. M

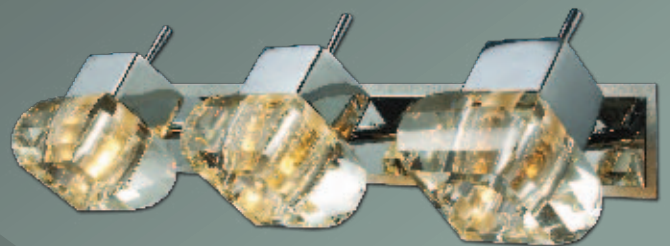

0564/3
 ↑ 94, ↔ 77,5
 3xG9 / 40W
 ⚡ 5 KB. M



0564/1
 ↑ 14, ↔ 20
 1xG9 / 40W
 ⚡ 2 KB. M



0564/4C
 ↑ 94, ↔ 84
 4xG9 / 40W
 ⚡ 6 KB. M

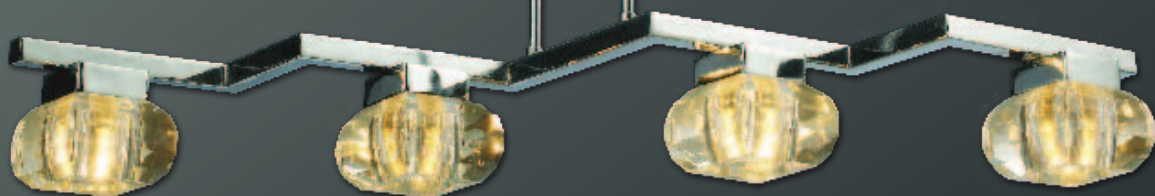

1021/1PC
 ↑ 18, ↔ 12
 1xGU10 / 50W
 ⚡ 4 KB. M



1021/3PC
 ↑ 50, ↔ 12
 3xGU10 / 50W
 ⚡ 12 KB. M



1021/2PC
 ↑ 34, ↔ 12
 2xGU10 / 50W
 ⚡ 8 KB. M



TRINI

FUSION

1095/3
 ↑ 98, ↔ 77
 3xE14 / 40W
 ⚡ 12 KB. M

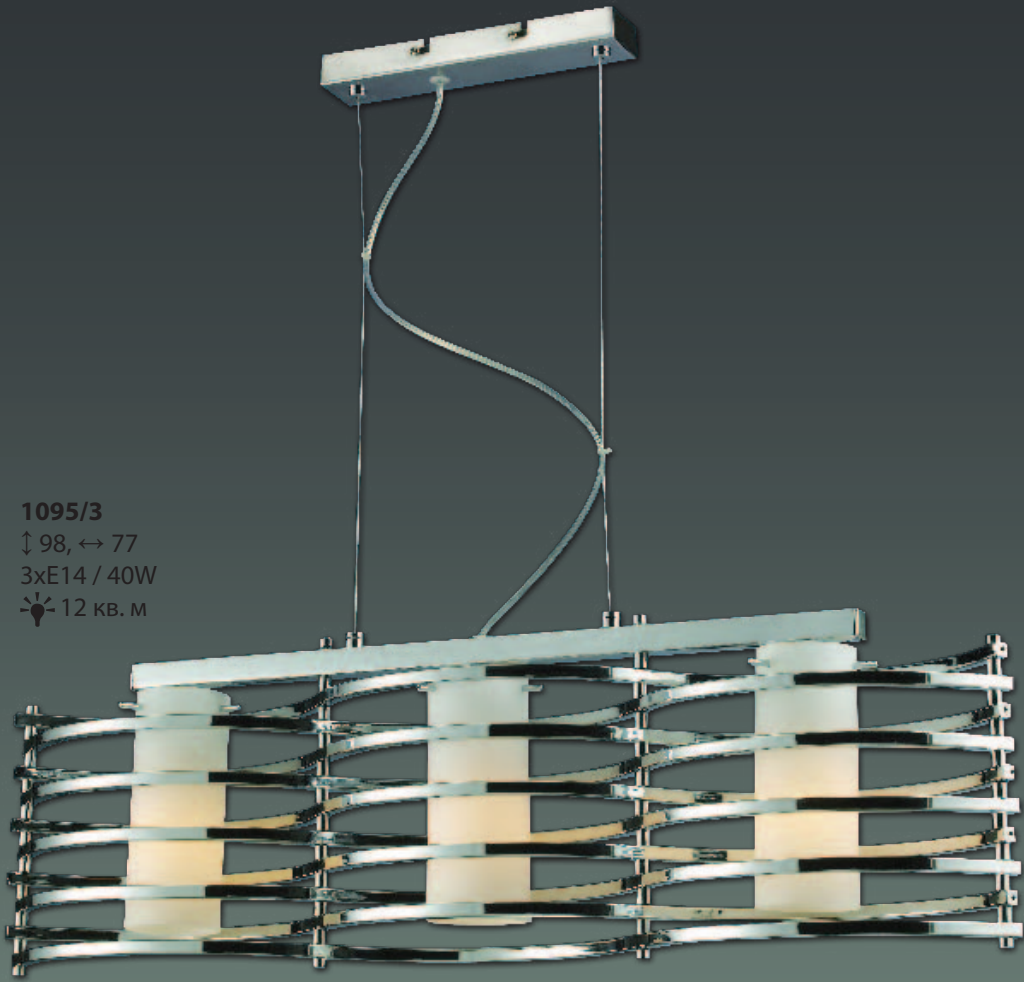

1095/2
 ↑ 95, ↔ 53
 2xE14 / 40W
 ⚡ 8 KB. M

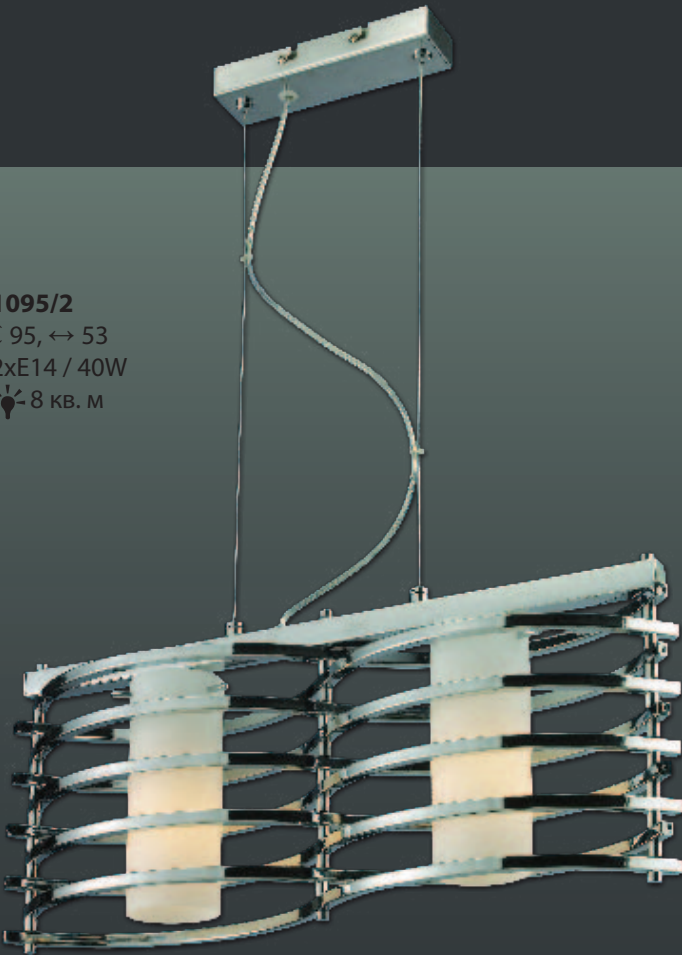

1101/1
 ↑ 110, ↔ 29,5
 1xE27 / 60W
 ⚡ 4 KB. M



SANDRA



1068/1
↕ 120, ↔ 36
1xE27 / 60W
💡 5 KB. M



SANDRA II

1068/2
 ↓ 120, ↔ 36
 2xE14 / 40W
 ⚡ 8 KB. M



1072/1
 ↓ 110, ↔ 14
 1xE14 / 40W
 ⚡ 3 KB. M

VERONIKA



1065/1
 ↓ 120, ↔ 30
 1xE27 / 60W
 ⚡ 4 KB. M

LUIGI



KRUZ

RICO



1031/1
↑ 103, ↔ 19
1xE27 / 60W
- 4 KB. M



1032/1LA
↑ 82, ↔ 28
1x E27 / 60W
- 4 KB. M



1032/1LB
↑ 26, ↔ 28
1xE27 / 60W
- 4 KB. M



1032/1SA
↑ 77, ↔ 18
1xE14 / 40W
- 3 KB. M

1032/1SB
↑ 18, ↔ 18
1xE14 / 40W
- 3 KB. M

LETTI

0712/1
↑ 80, ↔ 32,5
1x E27 / 60W
- 4 KB. M



IBBI

1805L/1P
↑ 130, ↔ 19,5
1xE27 / 60W
- 4 KB. M



0718/3B
 ↓ 33, ↔ 49
 3xE27 / 60W
 ⚡ 12 KB. M



0718/2
 ↓ 11, ↔ 40
 2xE27 / 60W
 ⚡ 8 KB. M

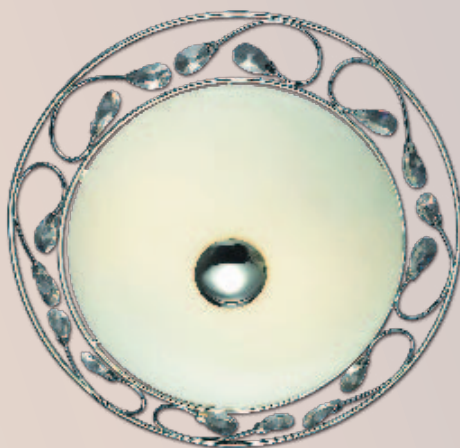

0718/1
 ↓ 8,5, ↔ 40
 1xE27 / 60W
 ⚡ 4 KB. M



1080/2A
 ↓ 7, ↔ 30
 2xE14 / 40W
 ⚡ 8 KB. M

1080/4
 ↓ 7, ↔ 40
 4xE14 / 40W
 ⚡ 14 KB. M

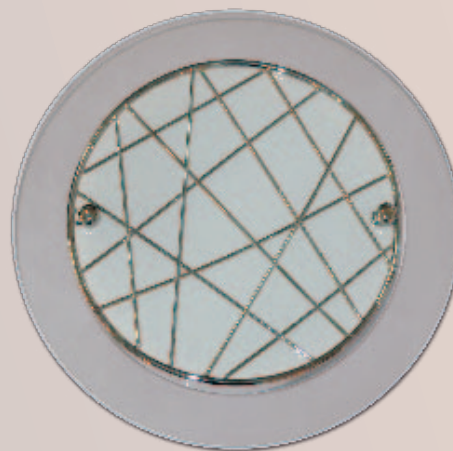

1080/2B
 ↓ 7, ↔ 30
 2xE14 / 40W
 ⚡ 8 KB. M

1080/3
 ↓ 7, ↔ 40
 3xE14 / 40W
 ⚡ 12 KB. M

0594/7

↑ 30, ↔ 78

7xE14 / 40W

💡 21 кв. м



0594/5

↑ 30, ↔ 64

5xE14 / 40W

💡 18 кв. м



0594/1

↑ 23, ↔ 21

1xE14 / 40W

💡 4 кв. м



BRUNO

0488/8

↑ 40, ↔ 72
8xE14 / 40W
☀ 22 KB. M



BERTA

0488/1W

↑ 19, ↔ 20
1xE14 / 40W
☀ 4 KB. M



0488/1

↑ 36, ↔ 14
1xE14 / 40W
☀ 4 KB. M



0488/5A

↑ 40, ↔ 58
5xE14 / 40W
☀ 18 KB. M



ODRI

0739/5A

↑ 40, ↔ 58

↑ 92, ↔ 58

5xE14 / 40W

💡 18 KB. M



0739/2

↑ 15,5, ↔ 34,5

2xE14 / 40W

💡 8 KB. M



0739/5B

↑ 31, ↔ 58

5xE14 / 40W

💡 18 KB. M

0735/5D

↓ 31, ↔ 58
5x E14 / 40W
⚡ 18 KB. M



0735/1

↓ 23,5, ↔ 22,5
1x E14 / 40W
⚡ 4 KB. M



0735/5B

↓ 40, ↔ 65
↓ 95, ↔ 65
5x E14 / 40W
⚡ 18 KB. M



0735/4

↓ 100, ↔ 105
4x E14 / 40W
⚡ 14 KB. M



LOREN

HELENA



0776/3B

↑ 40, ↔ 56

↑ 95, ↔ 56

3xE14 / 40W

💡 12 KB. M



0776/5A

↑ 35, ↔ 60

5xE14 / 40W

💡 18 KB. M



0776/2

↑ 21, ↔ 38

2xE14 / 40W

💡 8 KB. M



2656/8P
 ↓ 40, ↔ 68
 8xG9 / 40W
 ⚡ 13 KB. M



2656/5P
 ↓ 40, ↔ 46
 5xG9 / 40W
 ⚡ 9 KB. M



2656A/2W
 ↓ 18, ↔ 31
 2xG9 / 40W
 ⚡ 3 KB. M

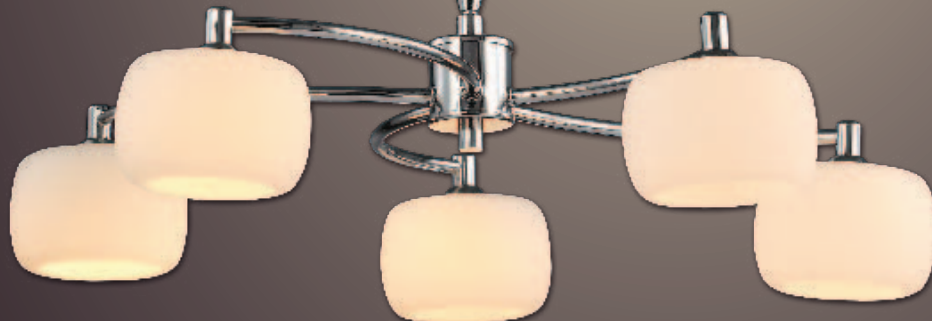

IRMA

ILMA



0749/8
↑ 40, ↔ 66
8xG9 / 40W
💡 13 KB. M

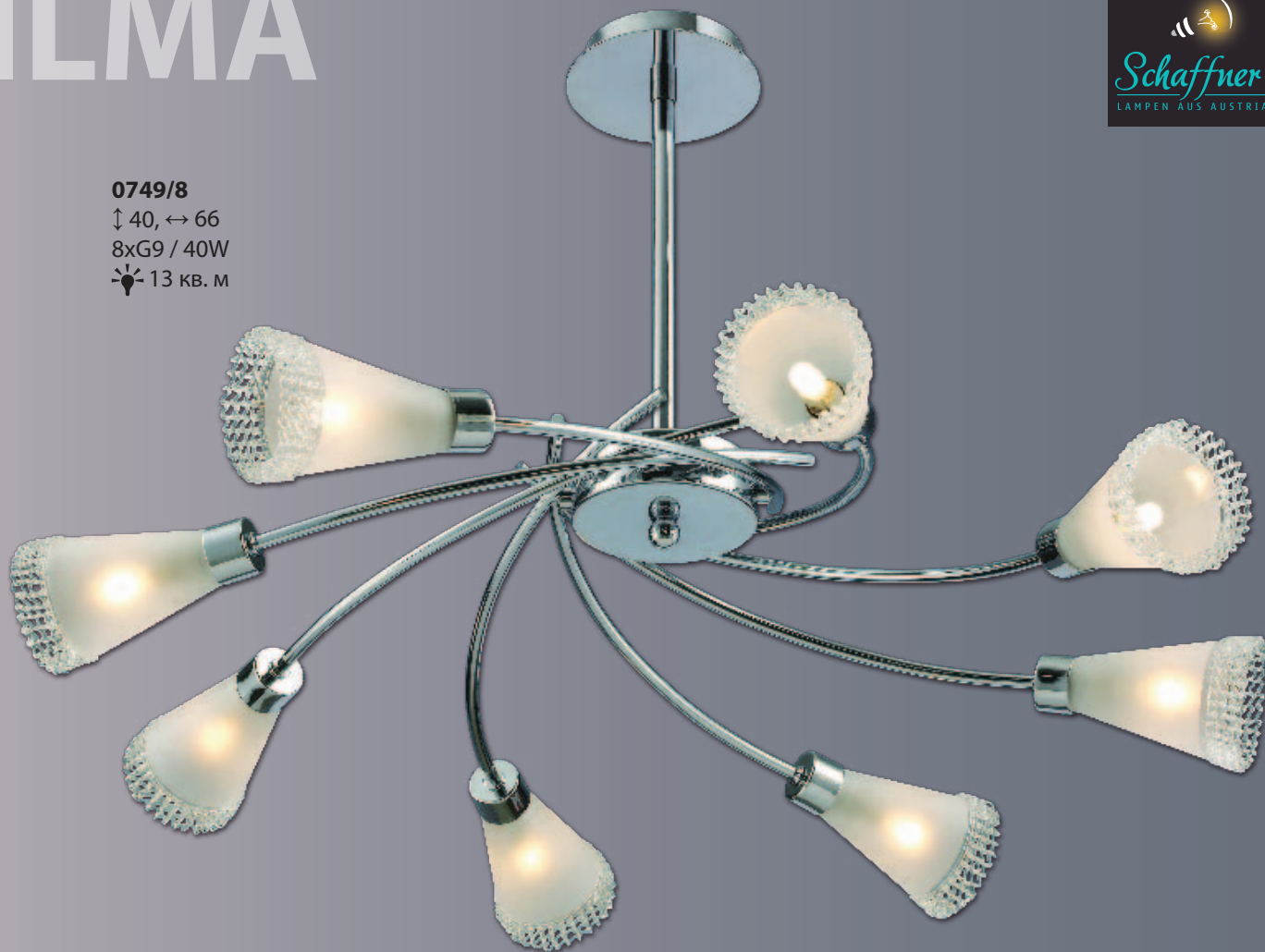

0749/5
↑ 39, ↔ 54
5xG9 / 40W
💡 9 KB. M

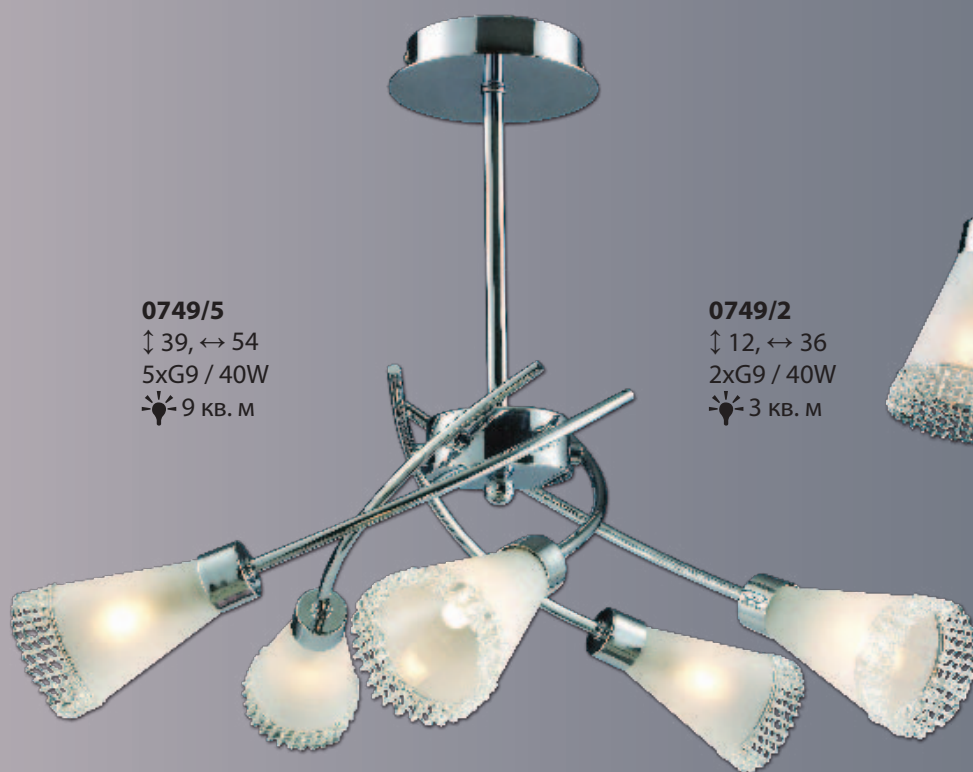

0749/2
↑ 12, ↔ 36
2xG9 / 40W
💡 3 KB. M





0629/8
 ↑ 40, ↔ 83
 ↑ 95, ↔ 83
 8xE14 / 40W
 ✨ 22 KB. M



0629/5
 ↑ 40, ↔ 73
 ↑ 95, ↔ 73
 5xE14 / 40W
 ✨ 18 KB. M



0628/2B
 ↑ 7, ↔ 37
 2xE14 / 40W
 ✨ 8 KB. M



1097/8A
↓ 24, ↔ 51,5
8xE14 / 40W
☀ 22 KB. M

STEFFANI

1097/6A
↓ 24, ↔ 54
6xE14 / 40W
☀ 20 KB. M



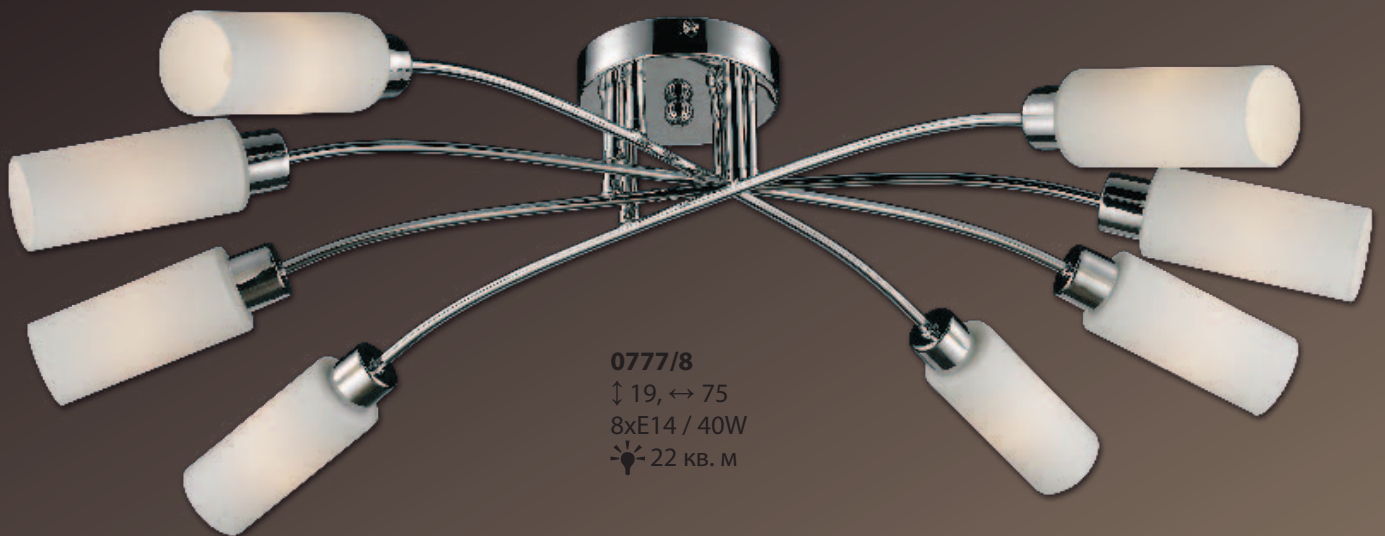

0777/8
↓ 19, ↔ 75
8xE14 / 40W
💡 22 KB. M

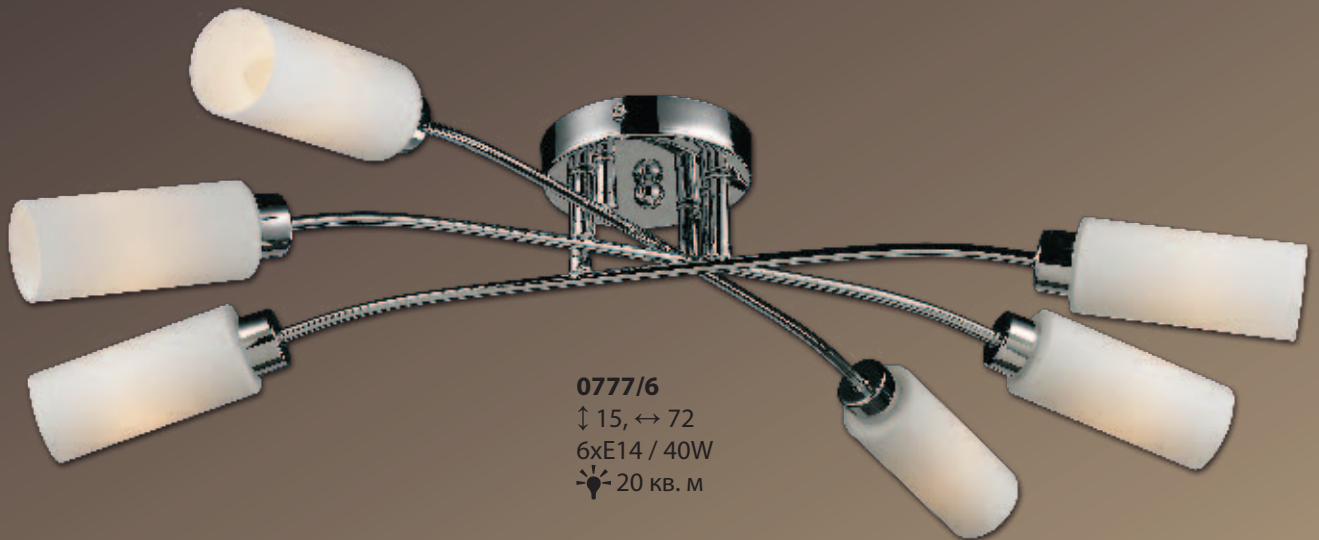

0777/6
↓ 15, ↔ 72
6xE14 / 40W
💡 20 KB. M

0777/2
↓ 8, ↔ 37,5
2xE14 / 40W
💡 8 KB. M



RICARDO

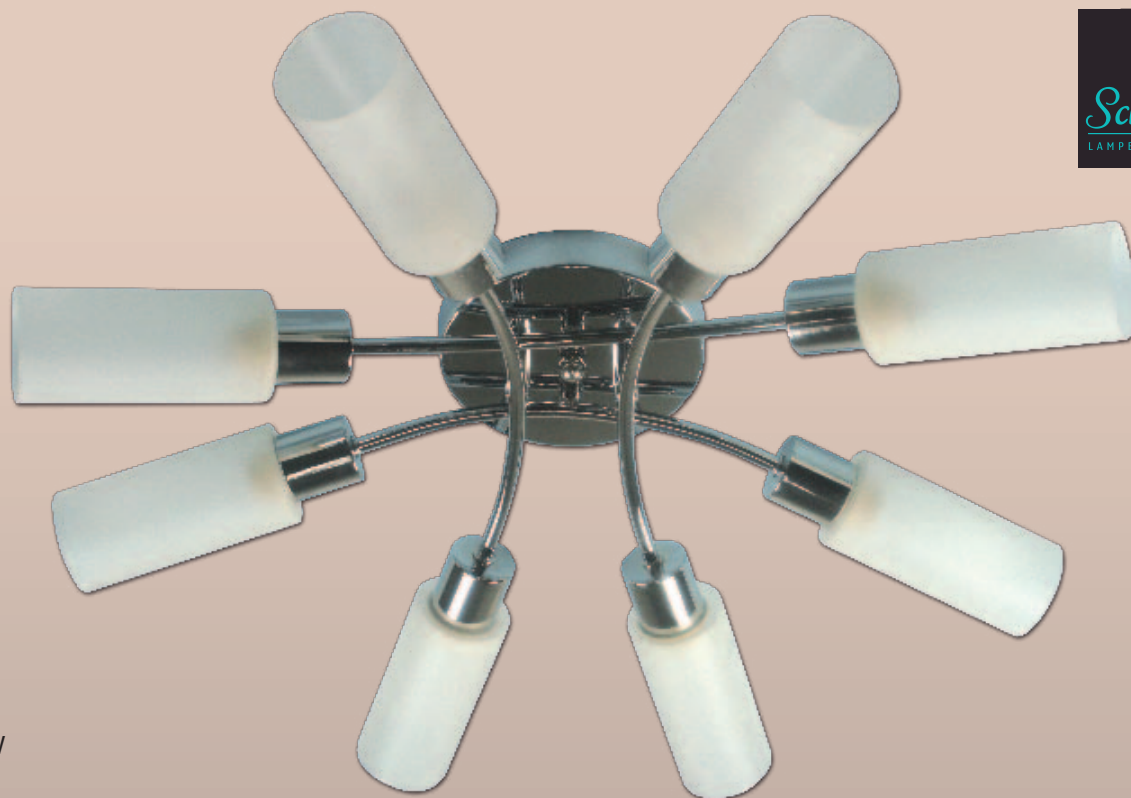

10036/8
 ↓ 12, ↔ 68
 8xE14 / 60W
 ⚡ 22 KB. M

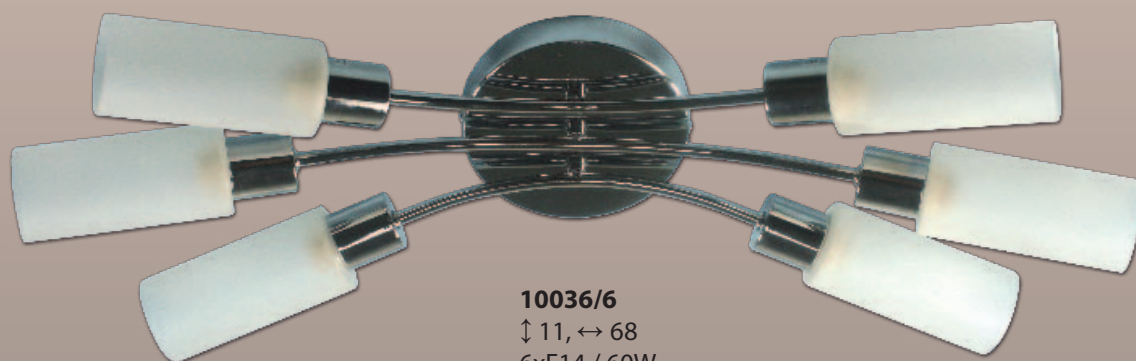

10036/6
 ↓ 11, ↔ 68
 6xE14 / 60W
 ⚡ 20 KB. M



10036/4
 ↓ 11, ↔ 51
 4xE14 / 60W
 ⚡ 14 KB. M



10036/1
 ↓ 31, ↔ 10
 1xE14 / 60W
 ⚡ 4 KB. M

HENRY

1176/1B
↓ 10, ↔ 22
1xE14 / 40W
☀️ 4 KB. M



BRAUNI

1212/1
↓ 11, ↔ 23
1xE14 / 40W
☀️ 4 KB. M



1212/2
↓ 10, ↔ 38
2xE14 / 40W
☀️ 8 KB. M





8028/6
↓ 29, ↔ 70
6xE14 / 60W
💡 20 кв. м



8028/4
↓ 29, ↔ 70
4xE14 / 60W
💡 14 кв. м



8028/2
↓ 30, ↔ 35
2xE14 / 60W
💡 8 кв. м

BRIGIT

8015/19
 ↓ 28, ↔ 51
 19xG4 / 20W
 ⚡ 25 KB. M

NADIN



ANDREA



6091-9
 ↓ 40, ↔ 60
 9xG4 / 20W
 ⚡ 14 KB. M

6091-13
 ↓ 45, ↔ 70
 13xG4 / 20W
 ⚡ 19 KB. M

GABRIEL

7204-9 ↓ 30, ↔ 70 9xG4 / 20W ⚡ 14 KB. M	7204-9 LED ↓ 30, ↔ 70 9xG4 / 20W ⚡ 14 KB. M
7204-13 ↓ 30, ↔ 85 13xG4 / 20W ⚡ 19 KB. M	7204-13 LED ↓ 30, ↔ 85 13xG4 / 20W ⚡ 19 KB. M



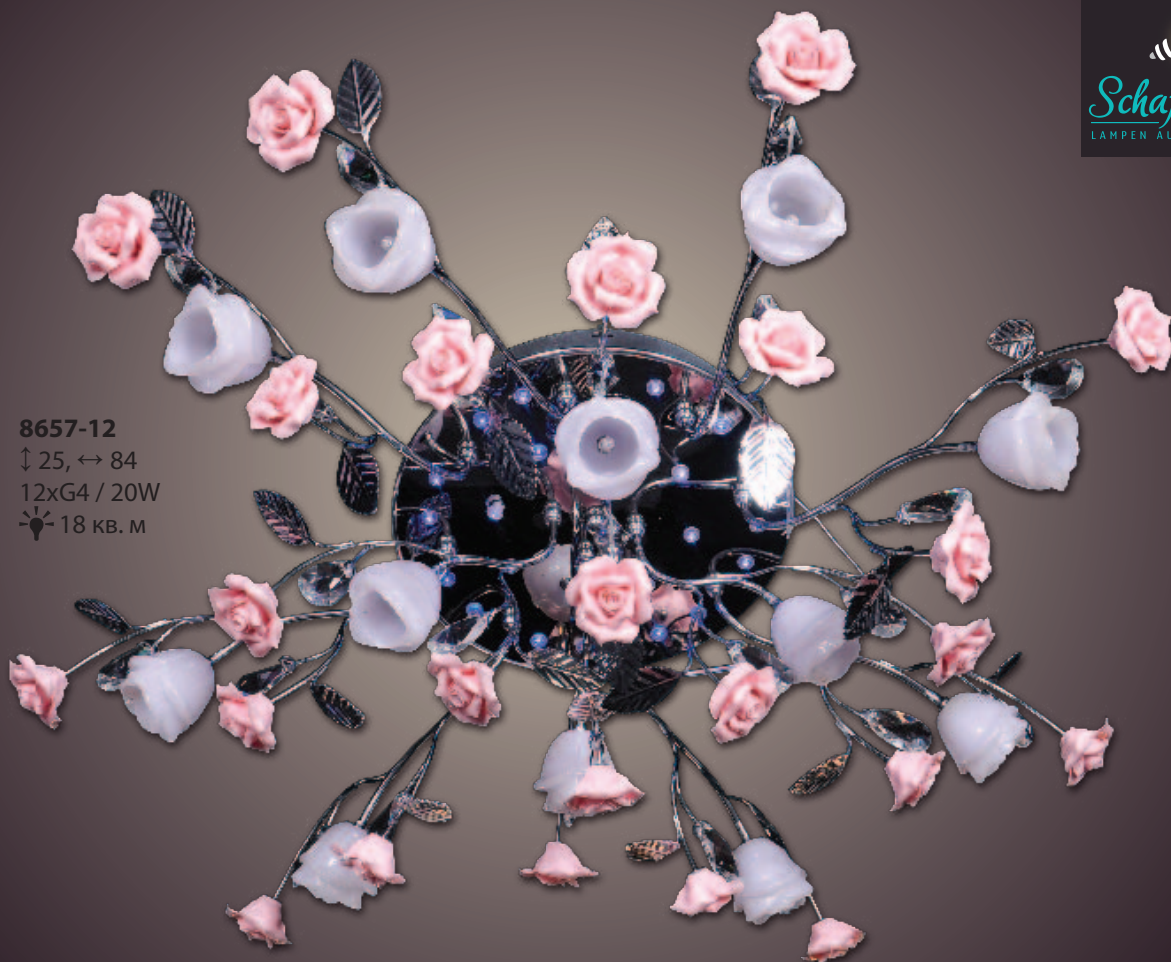

8657-12
↓ 25, ↔ 84
12xG4 / 20W
☀️ 18 KB. M

GERDA

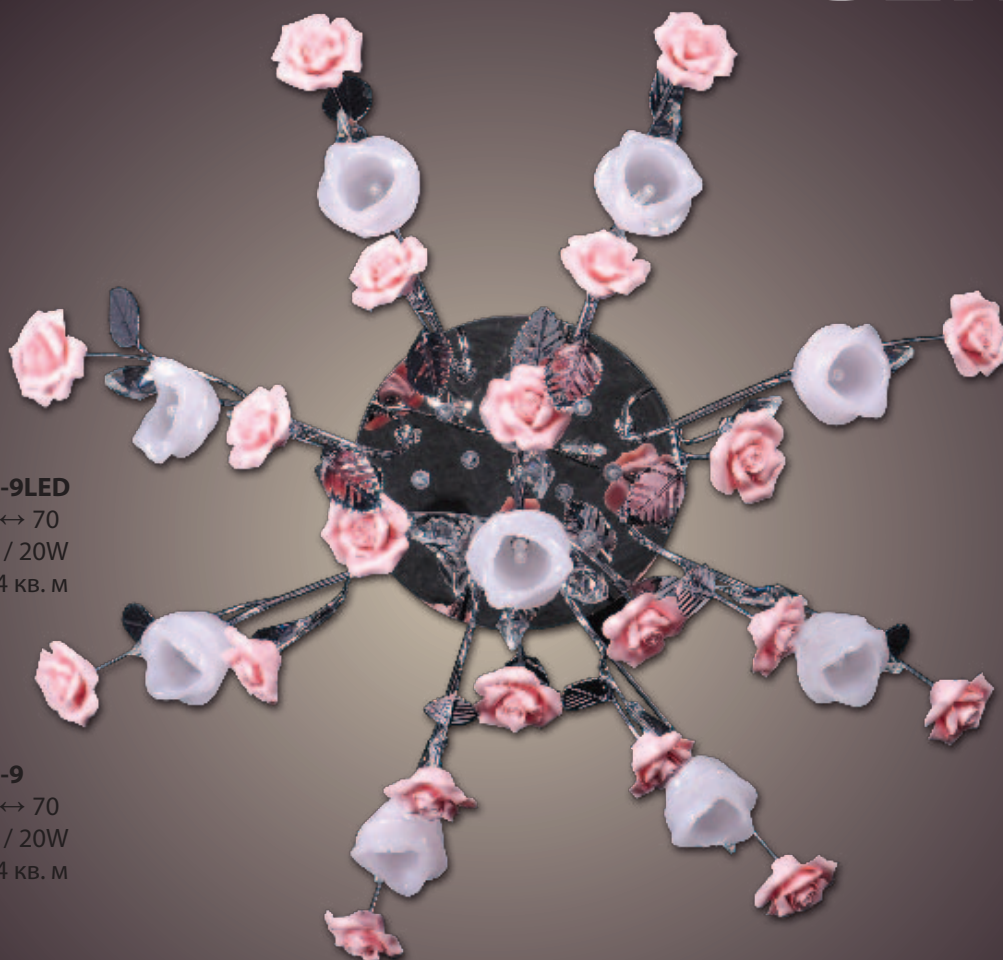

8657-9LED
↓ 25, ↔ 70
9xG4 / 20W
☀️ 14 KB. M

8657-9
↓ 25, ↔ 70
9xG4 / 20W
☀️ 14 KB. M

8652-12

↑ 25, ↔ 84

12xG4 / 20W

💡 18 KB. M

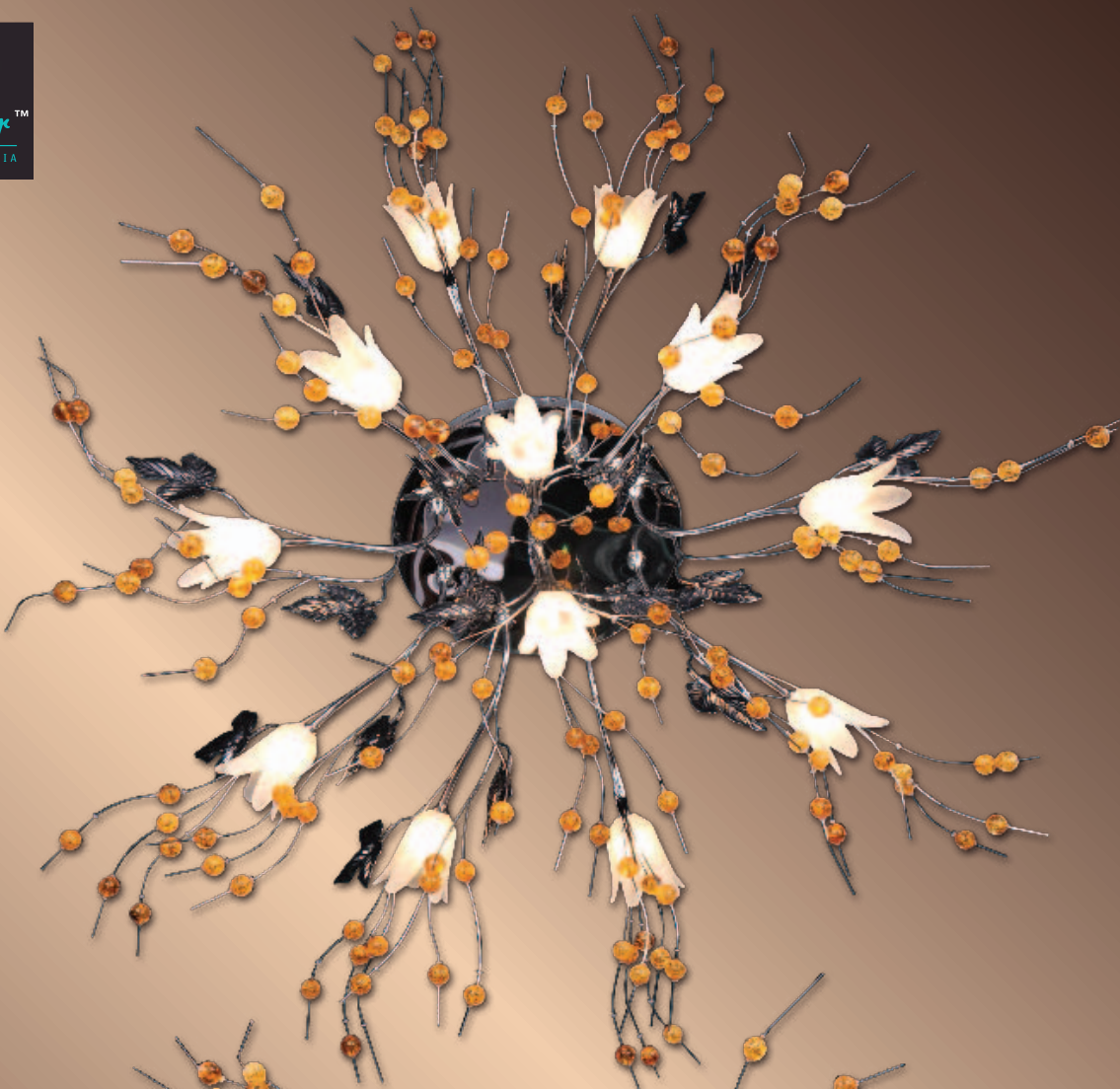

8652-9LED

↑ 30, ↔ 80

9xG4 / 20W

💡 14 KB. M

8652-9

↑ 30, ↔ 80

9xG4 / 20W

💡 14 KB. M



NICOLE



8660-12LED

↓ 18, ↔ 90
12xG4 / 20W
💡 18 KB. M

8660-5LED

↓ 20, ↔ 55
5xG4 / 20W
💡 9 KB. M

FRANCISKA



8661-12

↓ 60, ↔ 45
12xG4 / 20W
💡 18 KB. M

8661-15

↓ 50, ↔ 76
15xG4 / 20W
💡 21 KB. M



KARLIN

LAREY

7501-15

↓ 38, ↔ 50

15xG4 / 20W

💡 21 KB. M

7501-18

↓ 38, ↔ 55

18xG4 / 20W

💡 24 KB. M



ISADORA

6058-7 LED

↓ 35, ↔ 60

7xG4 / 20W

💡 11 KB. M



6058-12 LED

↓ 15, ↔ 85

12xG4 / 20W

💡 18 KB. M

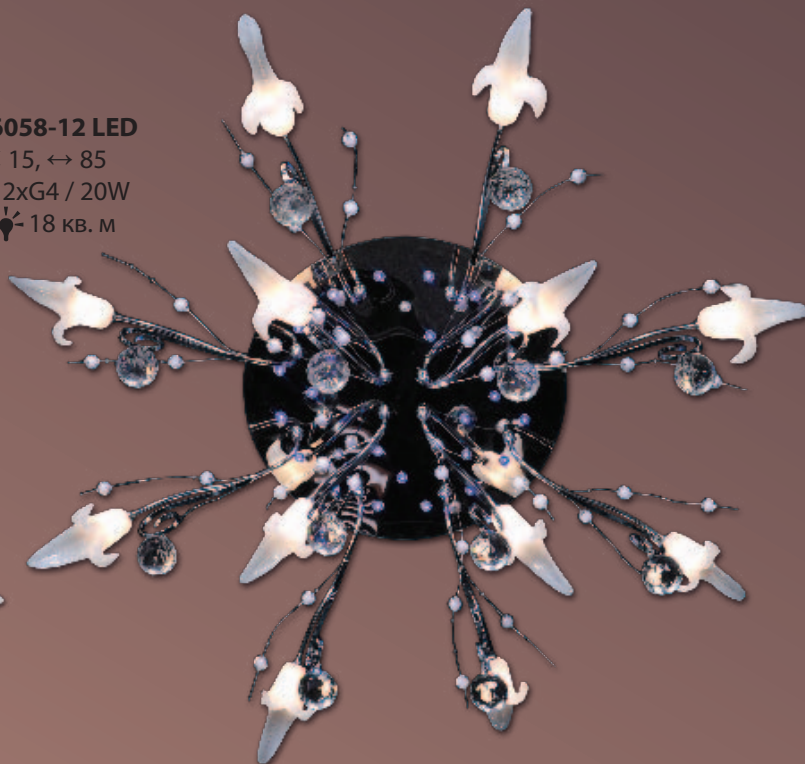



5220/7
↑ 17, ↔ 62
7xG4 / 20W
💡 11 кв. м

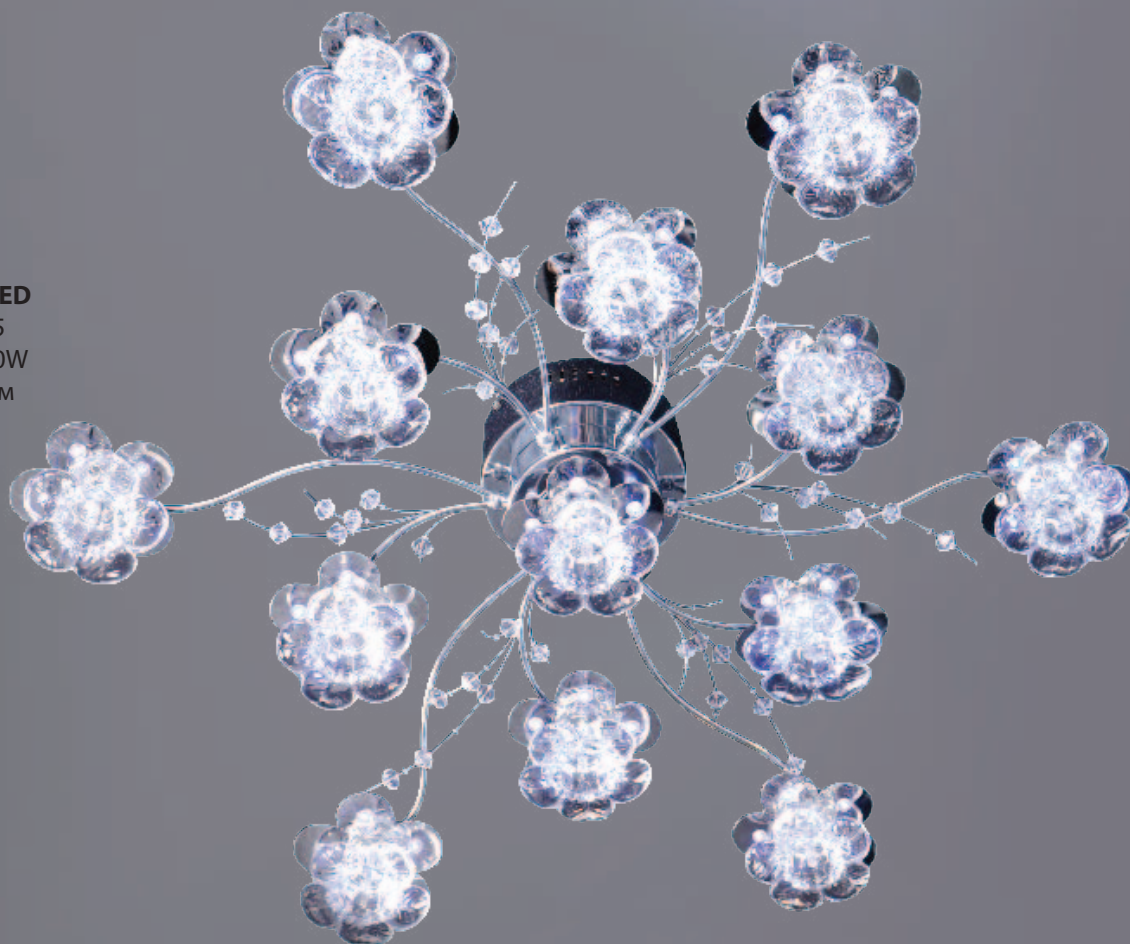

9561-13LED
↑ 20, ↔ 85
13xG4 / 20W
💡 19 кв. м

ELSA



7225-9LED

↓ 20, ↔ 80

9xG4 / 20W

☀ 14 KB. M

7230-9LED

↓ 15, ↔ 90

9xG4 / 20W

☀ 14 KB. M

7230-6LED

↓ 15, ↔ 80

6xG4 / 20W

☀ 10 KB. M

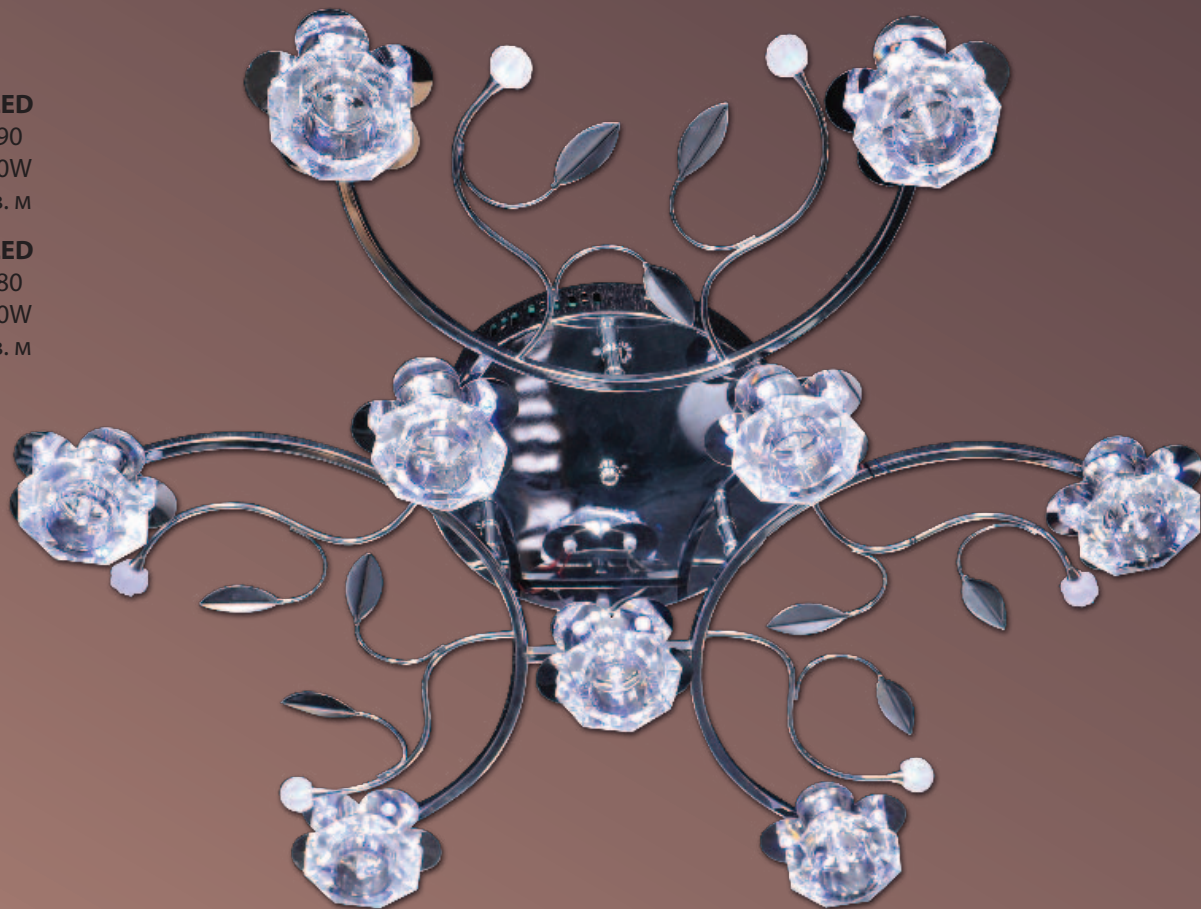

MARGARITA

ANIKA

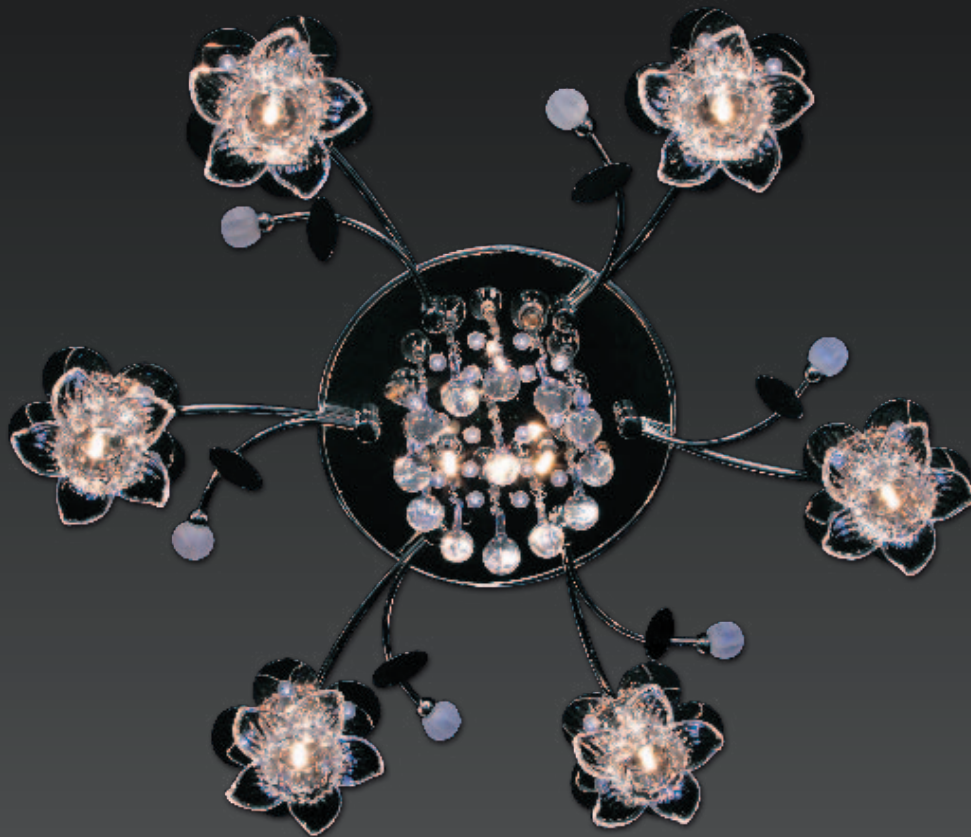

6045-9LED
↑ 18, ↔ 70
9xG4 / 20W
- 14 KB. M

6045-7LED
↑ 18, ↔ 60
7xG4 / 20W
- 11 KB. M

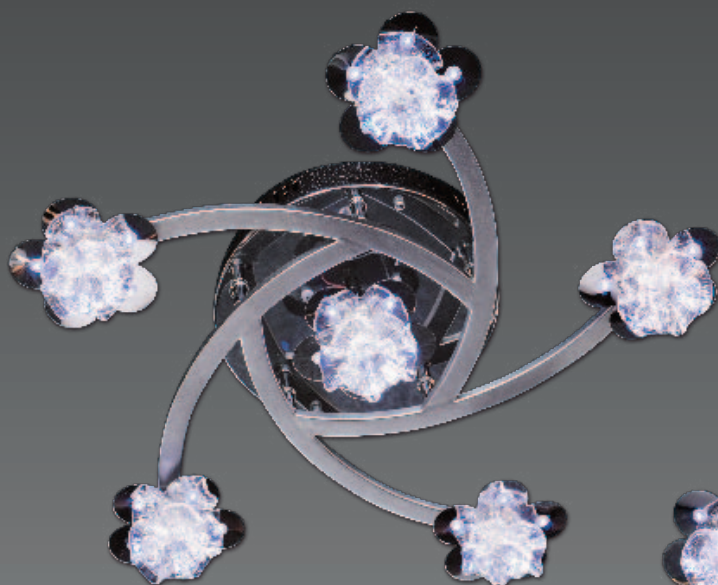

6085-6LED
↑ 15, ↔ 60
6xG4 / 20W
- 10 KB. M

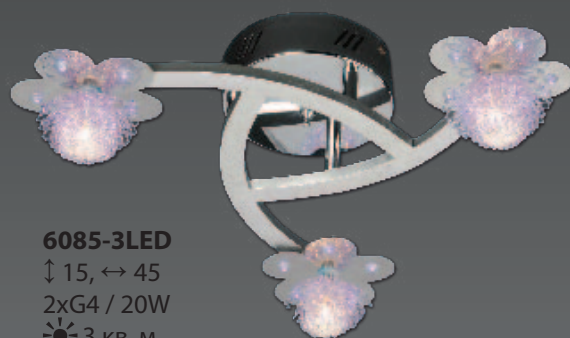

6085-3LED
↑ 15, ↔ 45
2xG4 / 20W
- 3 KB. M

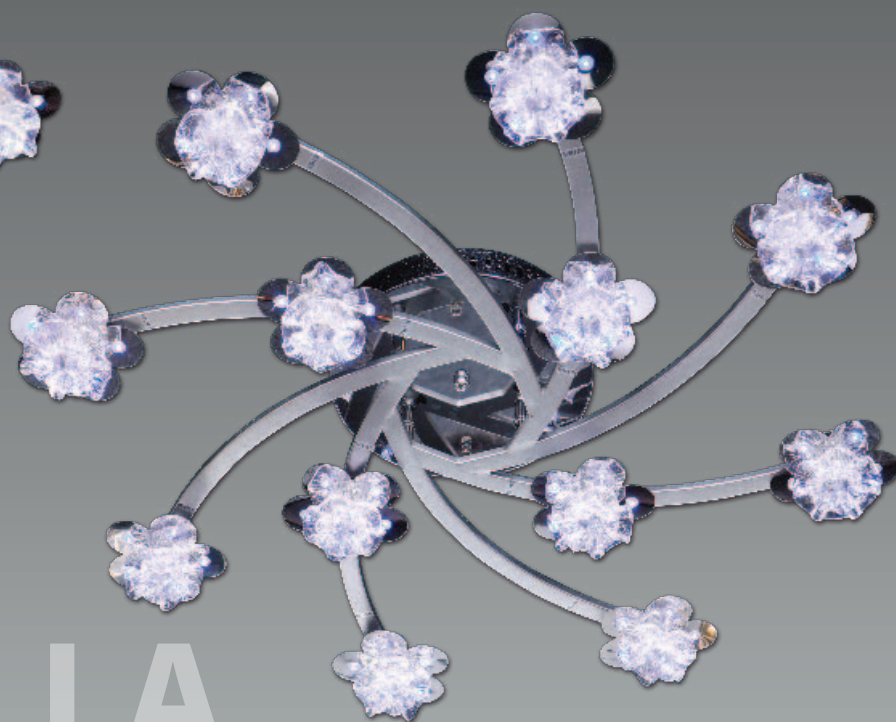

6085-12LED
↑ 15, ↔ 85
12xG4 / 20W
- 18 KB. M

RAFAELLA



5990/6

↓ 22, ↔ 65

6xG4 / 20W

☀ 10 KB. M



8303/6 (RGB)

↓ 24, ↔ 75

6xG4 / 20W

☀ 10 KB. M



LORE

8303/9 (RGB)

↓ 25, ↔ 66

9xG4 / 20W

☀ 14 KB. M



9671/13
↓ 25, ↔ 50,5
13xG4 / 20W
💡 19 кв. м



9671/12
↓ 25, ↔ 50
12xG4 / 20W
💡 18 кв. м



604/11
↓ 27, ↔ 45,5
11xG4 / 20W
💡 17 кв. м

LEONA

MARLIS



9652/10
↑ 23, ↔ 49,5
10xG4 / 20W
⚡ 16 KB. M

TERESA



9637/10
↑ 24, ↔ 50,5
10xG4 / 20W
⚡ 16 KB. M

ANABEL



9618/8

↑ 24, ↔ 50,5

8xG4 / 20W

💡 12 кв. м

9618/13

↑ 25,5, ↔ 60,5

13xG4 / 20W

💡 19 кв. м

MILENA

ELLA



9631/10

↑ 24, ↔ 49,5

10xG4 / 20W

💡 16 кв. м

9631/15

↑ 24, ↔ 59,5

15xG4 / 20W

💡 21 кв. м



8907/9
↓ 22, ↔ 50,5
9xG4 / 20W
💡 14 KB. M

MILA

REBEKA



9667/10
↓ 23, ↔ 49,5
10xG4 / 20W
💡 16 KB. M

9667/16
↓ 23, ↔ 59,5
16xG4 / 20W
💡 22 KB. M

2215-1
 ↓ 127, ↔ 15
 1xG4 / 20W
 ⚡ 2 KB. M



2213-1
 ↓ 131, ↔ 12
 1xG10 / 20W
 ⚡ 4 KB. M



2043-1
 ↓ 135, ↔ 15
 1xG10 / 20W
 ⚡ 4 KB. M



2008-1
 ↓ 131, ↔ 10
 3xG4 / 20W
 ⚡ 5 KB. M



RUD MAD IDAN ILS



2151/5P
 ↓ 100, ↔ 64
 5xE14 / 60W
 ⚡ 18 KB. M

SOFIE

2151/3P
 ↓ 100, ↔ 62
 3xE14 / 20W
 ⚡ 9 KB. M



2151/1W
 ↓ 50, ↔ 15
 1xE14 / 60W
 ⚡ 4 KB. M



2564/8P
↑ 120, ↔ 102
8xE14 / 40W
💡 22 KB. M

SABINA



2564/2W
↑ 35,2, ↔ 45,3
2xE14 / 40W
💡 8 KB. M



8085/5

↑ 36, ↔ 66

5xE27 / 60W

💡 18 KB. M



SIGGI

8085/3

↑ 36, ↔ 66

3xE27 / 60W

💡 12 KB. M



8088/1W

↑ 23, ↔ 28

1xE27 / 60W

💡 4 KB. M

97024/5
 ↓ 53, ↔ 56
 5xE14 / 60W
 ✨ 18 KB. M



97024/1
 ↓ 22, ↔ 13
 1xE14 / 60W
 ✨ 4 KB. M

97024/3
 ↓ 53, ↔ 56
 3xE14 / 60W
 ✨ 12 KB. M



MINNI

90746C/6
↓ 42, ↔ 70
6xE27 / 60W
💡 20 KB. M



90746C/2
↓ 26, ↔ 42
2xE14 / 60W
💡 8 KB. M

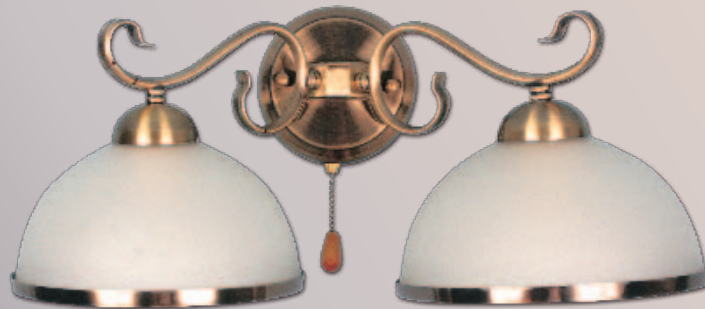

KLARA

90746C/2
↓ 41, ↔ 52
2xE27 / 60W
💡 8 KB. M



90746C/5
↓ 42, ↔ 56
5x E27 / 60W
💡 18 KB. M



90746C/1
↓ 26, ↔ 18
1x E14 / 60W
💡 4 KB. M



90746C/3
↓ 41, ↔ 52
3x E27 / 60W
💡 12 KB. M



KLARA

8097/5
↑ 27, ↔ 55
5xE14 / 40W
⚡ 18 KB. M



8097/3
↑ 27, ↔ 55
3xE14 / 40W
⚡ 12 KB. M



8097/1W
↑ 22, ↔ 25
1xE14 / 40W
⚡ 4 KB. M



EMMA

3031/5

↑ 33, ↔ 68

5x E27 / 60W

💡 18 KB. M



HILDA

3031/3

↑ 33, ↔ 68

3x E27 / 60W

💡 12 KB. M





01211-5
↑ 29, ↔ 65
5xE14 / 60W
- 18 KB. M

AGNA



01211-3
↑ 29, ↔ 65
3xE14 / 60W
- 12 KB. M



2047/5C
↓ 21,2, ↔ 56,5
5xE14 / 40W
☀ 18 кв. м

TILL



2047/8C
↓ 21,2, ↔ 66,5
8xE14 / 40W
☀ 22 кв. м



2231/5C

↑ 15,2, ↔ 60,7

5xE14 / 40W

☀ 18 KB. M

BINDI



2231/10C

↑ 18,3, ↔ 85

10xE14 / 40W

☀ 26 KB. M



90458/8
↑ 27, ↔ 78
8xE14 / 60W
💡 22 кв. м



90458/6
↑ 28, ↔ 78
6xE14 / 60W
💡 20 кв. м

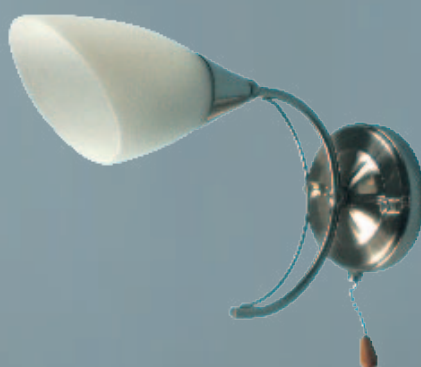

90458/1
↑ 23, ↔ 11
1xE14 / 60W
💡 4 кв. м

ROZMARI



90374E/9
↑ 36, ↔ 78
9xE14 / 60W
💡 23 кв. м



90374E/5
↑ 24, ↔ 78
5xE14 / 60W
💡 18 кв. м

FRIDA



90308C/6
↑ 17, ↔ 63
6xE14 / 60W
💡 20 KB. M



90308C/3
↑ 17, ↔ 59
3xE14 / 60W
💡 12 KB. M

ZARA



01212-3
↑ 42, ↔ 54
3xG9 / 40W
💡 5 KB. M



01212-4
↑ 42, ↔ 62
4xG9 / 40W
💡 6 KB. M

KLAUS

3025/5
↑ 30, ↔ 60
5xE14 / 40W
💡 18 KB. M



3025/5 (up)
↑ 30, ↔ 60
5xE14 / 40W
💡 18 KB. M



3025/1W
↑ 23, ↔ 17
1xE14 / 40W
💡 4 KB. M



3025/3
↑ 30, ↔ 60
3xE14 / 40W
💡 12 KB. M



3025/3 (up)
↑ 30, ↔ 60
3xE14 / 40W
💡 12 KB. M



NINELLE

90741B/5
↑ 34, ↔ 57
5x E14 / 60W
☀ 18 KB. M



ROKSANA

90741B/1
↑ 34, ↔ 16
1x E14 / 60W
☀ 4 KB. M



90741B/3
↑ 34, ↔ 57
3x E14 / 60W
☀ 12 KB. M





96128A/8
↑ 60, ↔ 58
8xE14 / 60W
☀️ 22 KB. M

96128A/1
↑ 17, ↔ 21
1xE14 / 60W
☀️ 4 KB. M



96128A/3
↑ 60, ↔ 47
3xE14 / 60W
☀️ 12 KB. M



96128A/5
↑ 60, ↔ 47
5xE14 / 60W
☀️ 18 KB. M



KLEO



90801A/6
 ↑ 26, ↔ 57
 6xE14 / 60W
 ⚡ 20 KB. M

HANNA



90801A/3
 ↑ 26, ↔ 51
 3xE14 / 60W
 ⚡ 12 KB. M



90801A/1
 ↑ 35, ↔ 18
 1xE14 / 60W
 ⚡ 4 KB. M



90801A/5
 ↑ 26, ↔ 51
 5xE14 / 60W
 ⚡ 18 KB. M



10062/5
↓ 16, ↔ 50
5x E14 / 60W
☀ 18 KB. M

10062/1
↓ 39, ↔ 17
1x E14 / 60W
☀ 4 KB. M

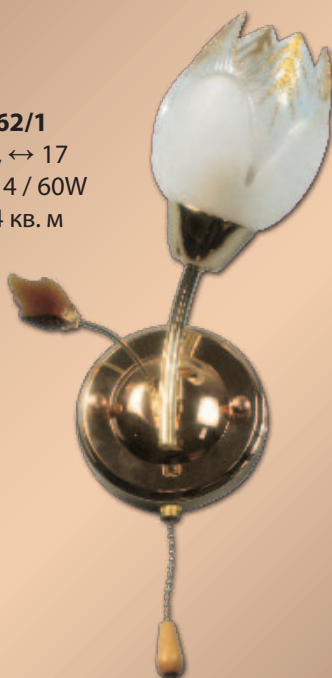

10062/3
↓ 16, ↔ 51
3x E14 / 60W
☀ 12 KB. M



FIONA

CHRISTIAN



90630F/6
 ↓ 22, ↔ 58
 6xE14 / 60W
 ✨ 20 KB. M



90630F/1
 ↓ 43, ↔ 31
 1xE14 / 60W
 ✨ 4 KB. M



90630F/4
 ↓ 22, ↔ 76
 4xE14 / 60W
 ✨ 14 KB. M

10062/6
 ↓ 28, ↔ 60
 6xE27 / 60W
 ⚡ 20 KB. M



LOT



10039/1
 ↓ 26, ↔ 18
 1xE14 / 60W
 ⚡ 4 KB. M



10039/6
 ↓ 21, ↔ 56
 6xE14 / 60W
 ⚡ 20 KB. M



10039/4
 ↓ 21, ↔ 61
 4xE14 / 60W
 ⚡ 14 KB. M

JINA

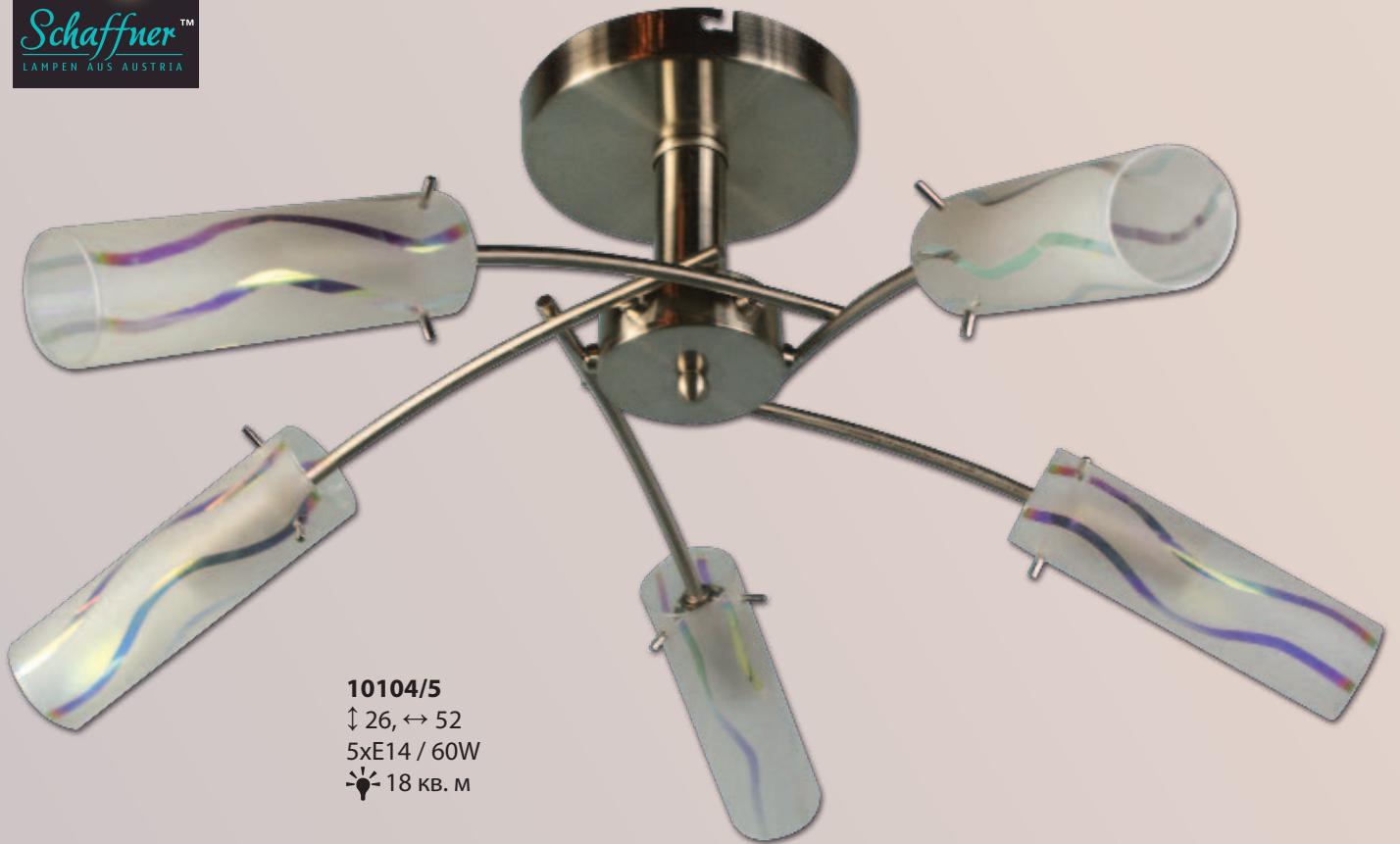

10104/5
 ↑ 26, ↔ 52
 5xE14 / 60W
 ✨ 18 KB. M

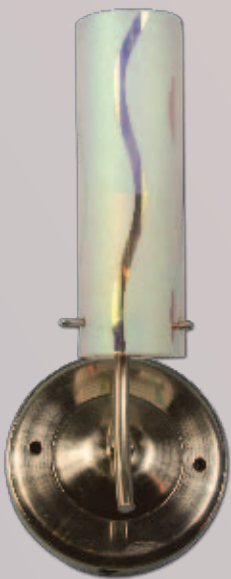

10104/1
 ↑ 25, ↔ 10
 1xE14 / 60W
 ✨ 4 KB. M

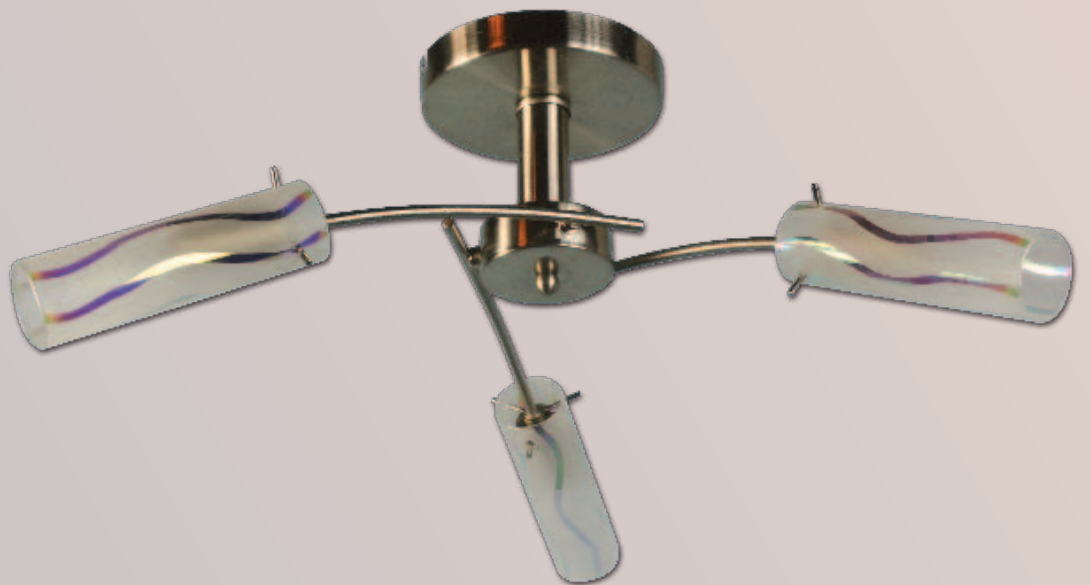

10104/3
 ↑ 26, ↔ 42
 3xE14 / 60W
 ✨ 12 KB. M

ARTUR



3042/3P
↑ 90, ↔ 55
3xE27 / 60W
💡 12 KB. M

KARINA

LINDA

96159B/1

↑ 75, ↔ 40

1xE27 / 60W

💡-4 KB. M



96173/1

↑ 66, ↔ 40

1xE27 / 60W

💡-4 KB. M



LISA

BETTI
668/7
↓ 6, ↔ 23
1xE14/40W
💡 3 KB. M



BETTI
668/9
↓ 6, ↔ 28
2xE14 / 60W
💡 8 KB. M



BETTI
668/11
↓ 6, ↔ 33
3xE14 / 60W
💡 12 KB. M



BETTI

Настольные и напольные светильники



1986/3T
↓ 49,5, ↔ 18
3xG4 / 10W
💡 - 5 кв. м



1986/6F
↓ 170, ↔ 30
6xG4 / 10W
💡 - 10 кв. м

Настольные и напольные светильники



2303/1F
↓ 156, ↔ 47
1xE27 / 100W
💡 4 кв. м



2303/1T
↓ 64, ↔ 32,5
1xE27 / 60W
💡 4 кв. м

Настольные и напольные светильники



2410/1T
↑ 68, ↔ 38
1xE27 / 60W
💡 4 KB. M



2410/1F
↑ 150, ↔ 38
1xE27 / 100W
💡 4 KB. M



Настольные и напольные светильники



2507/4F

↑ 176,4, ↔ 22

4xG9 / 40W

💡 6 кв. м

2507/1T

↑ 32,5, ↔ 12

1xG9 / 40W

💡 2 кв. м

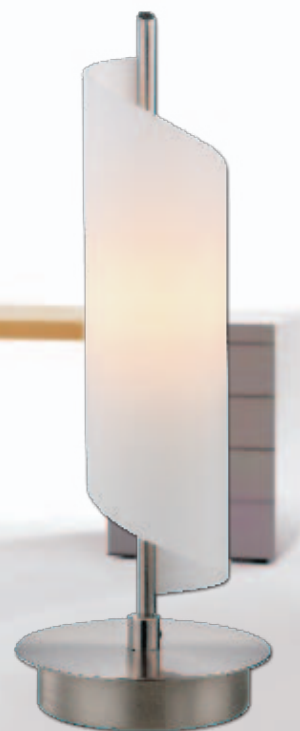
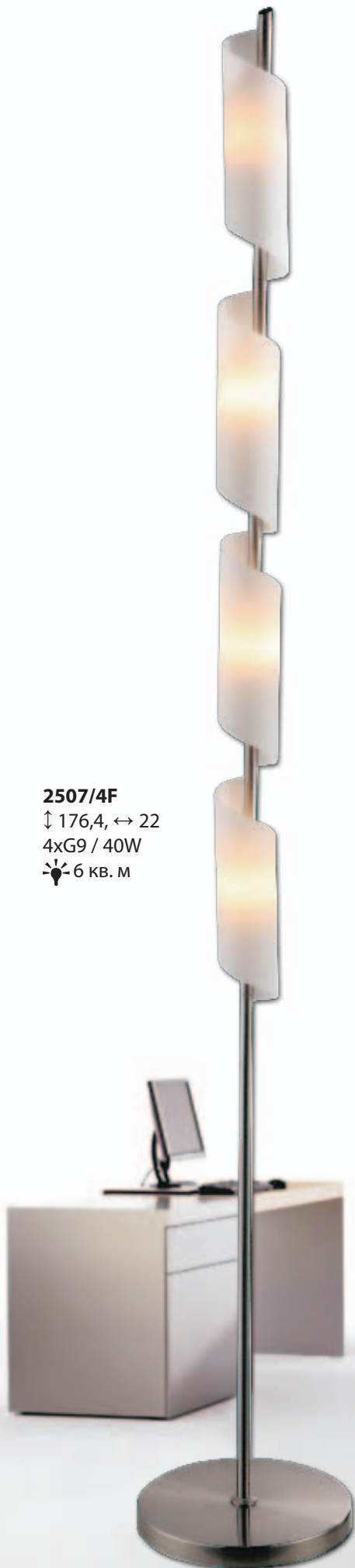

Настольные и напольные светильники



2424/1T
↓ 66, ↔ 40
1xE27 / 60W
💡 4 КВ. М



2424/1F
↓ 186, ↔ 54
1xE27 / 100W
💡 4 КВ. М

MX435-Y40(YS)

T6, 4000K

мощность: 40W

тип лампы: T6

↓ 10,5, ↔ 42

💡 8-13 кв. м



MX3434-Y38(BQ)

2D, 6500K

мощность: 38W

тип лампы: 2D

↓ 6,5, ↔ 34,5

💡 8-13 кв. м



MX3535-Y28(FZ)

2D, 6500K

мощность: 28W

тип лампы: 2D

↓ 9, ↔ 40

💡 8-13 кв. м



MD400D-Y15*3

Radiance

Мощность: 15W energy saving lamps

Тип ламп: 3xE27

↓ 100, ↔ 40

☀ 12 кв. м



MD550D-Y15*3

Radiance

Мощность: 15W energy saving lamps

Тип ламп: 3xE27

↓ 100, ↔ 55

☀ 12 кв. м



MD550F-Y15*3

Elegant Cone

Мощность: 15W energy saving lamps

Тип ламп: 3xE27

↓ 100, ↔ 55

☀ 12 кв. м

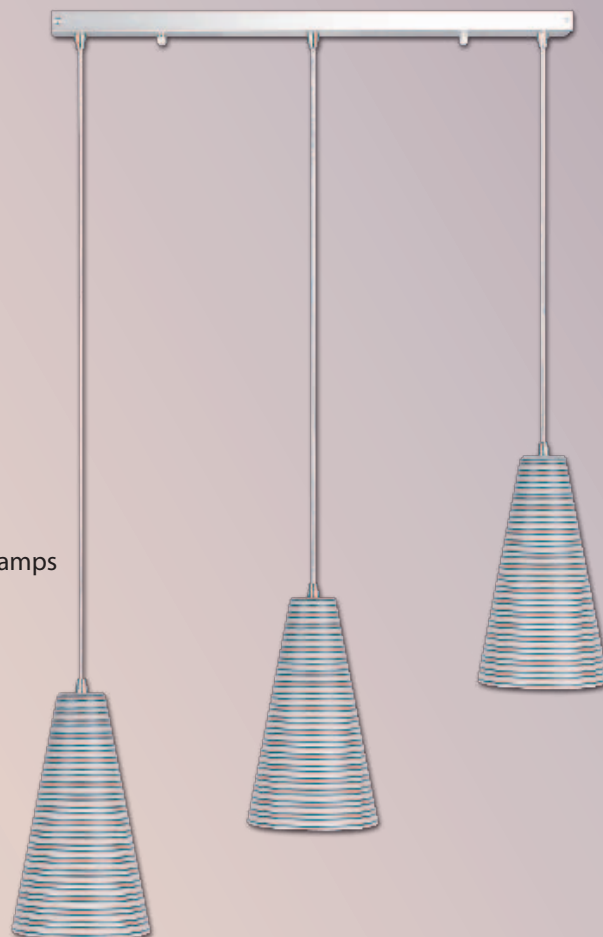

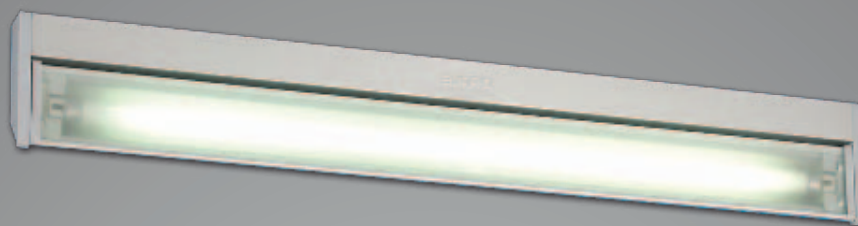

MB549-Y24Z (Xingdong)

Мощность: 24W
 Тип лампы: T5-HO-24W
 ↑ 9, ↔ 60
 ✨ 5-8 кв. м

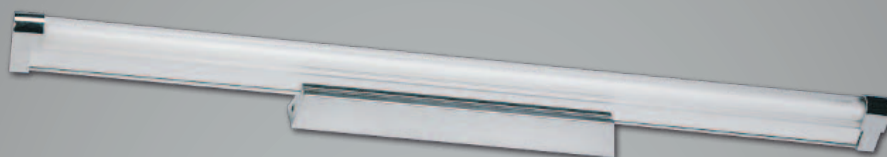

MX549-Y24 (Liangjing)

Мощность: 24W
 Тип лампы: T5-HO-24W
 ↑ 3,5, ↔ 57,5
 ✨ 5-8 кв. м

**MX586-Y83
 (KZLG)-Blue**

Мощность: 83W
 Тип лампы: T6 кольцевая
 ↑ 8, ↔ 58
 ✨ 16-28 кв. м



**MX300-Y22
 (QY)-Blue**

Мощность: 22W
 Тип лампы: T5 кольцевая
 ↑ 9, ↔ 37
 ✨ 4-7 кв. м



**MX500-Y28+38
 (QY)-Blue/Amber/Violet**

Мощность: 28+38W
 Тип лампы: T5 кольцевая
 ↑ 10, ↔ 56
 ✨ 10-15 кв. м



MX1860-Y10

Мощность: 10W

Тип лампы: 2D

↑ 6,2, ↔ 17,2

💡 2-3 кв. м

**MX200-Y21(XFB)**

Мощность: 21W

Тип лампы: 2D

↑ 7,5, ↔ 22

💡 4-7 кв. м

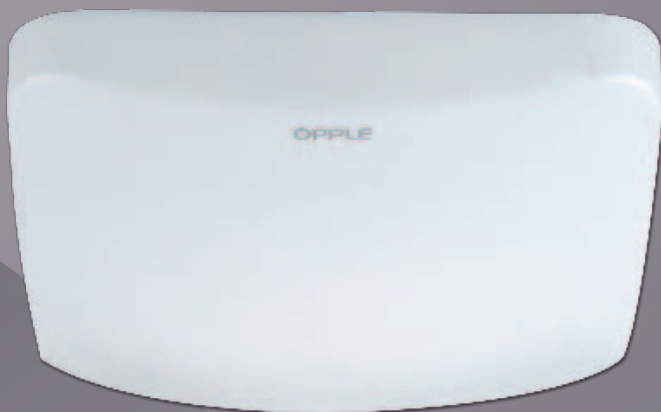
**MX801-Y21(XF)**

Мощность: 21W

Тип лампы: 2D

↑ 5,8, ↔ 19

💡 4-7 кв. м

**MX803-Y21(XY)**

Мощность: 21W

Тип лампы: 2D

↑ 5,8, ↔ 22

💡 4-7 кв. м



MX500-Y28+38 (QBYB)

Мощность: 28+38W
 Тип лампы: T5 кольцевая
 ↓ 12,7, ↔ 50
 ☀️ 13-22 кв. м



MX420-Y40 (HY)

Мощность: 40W
 Тип лампы: T6 кольцевая
 ↓ 12,7, ↔ 42
 ☀️ 8-13 кв. м



MX500-Y28+38 (HY)

Мощность: 28+38W
 Тип лампы: T5 кольцевая
 ↓ 12,7, ↔ 50
 ☀️ 13-22 кв. м

MX300-Y22 (QB)

Мощность: 22W
 Тип лампы: T5 кольцевая
 ↓ 12,7, ↔ 30
 ☀️ 4-7 кв. м



MX420-Y40 (QB)

Мощность: 40W
 Тип лампы: T6 кольцевая
 ↓ 12,7, ↔ 42
 ☀️ 8-13 кв. м

MX300-Y22 (YW)

Мощность: 22W
 Тип лампы: T5 кольцевая
 ↓ 12,7, ↔ 30
 ☀️ 4-7 кв. м

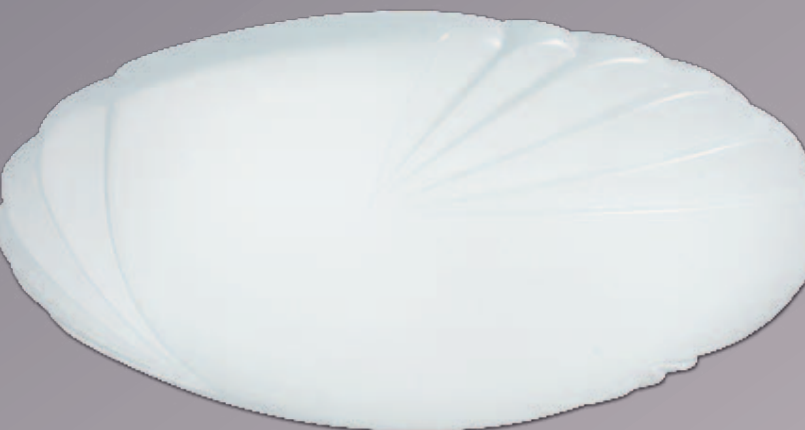

MX420-Y40 (YW)

Мощность: 40W
 Тип лампы: T6 кольцевая
 ↓ 12,7, ↔ 42
 ☀️ 8-13 кв. м

MD500-Y60-TSGH (Silver Gray)

Мощность: 60W

Тип лампы: T5 кольцевая

↓ 11,5, ↔ 50

💡 10-15 кв. м

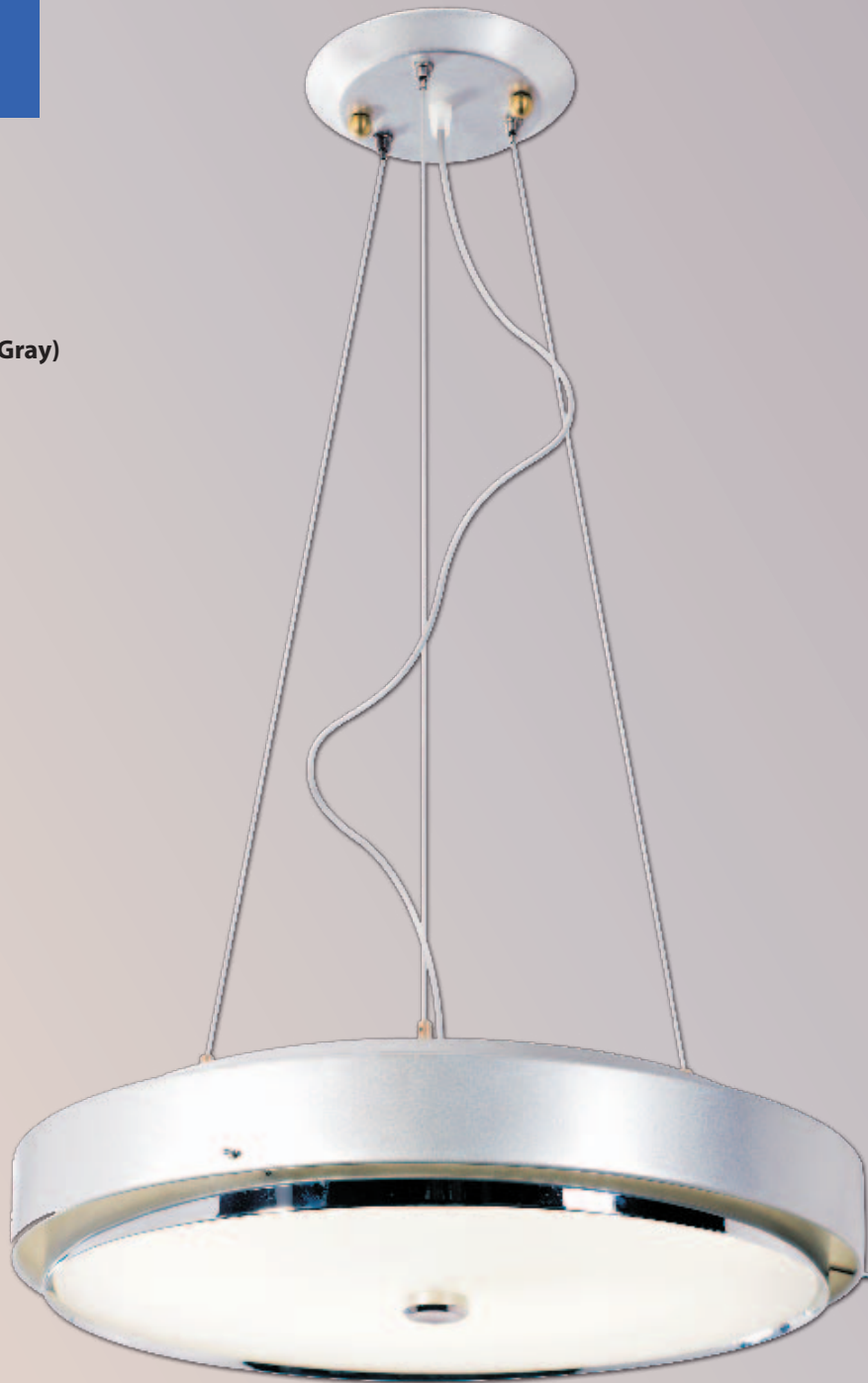

**MX500E-Y60-TSGH
(Silver Gray)**

Мощность: 60W

Тип лампы: T5 кольцевая

↓ 10, ↔ 50

💡 13-16 кв. м



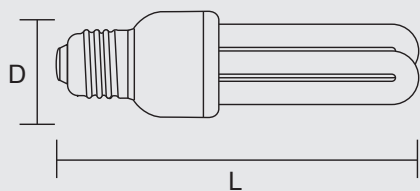

модель	мощность	цветовая температура	цоколь	D (мм)	L (мм)	диаметр трубки	количество /коробка	размер коробки (мм)
YPZ220/11-3US	11w	2700	E14	40,5	124	9	50	455*230*155
YPZ220/20-3U	20w	4000	E27	54	178	12	50	605*300*215

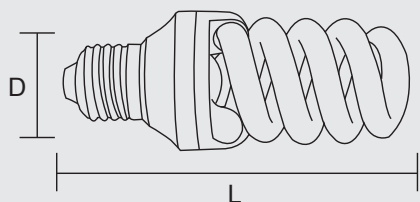

модель	мощность	цветовая температура	цоколь	D (мм)	L (мм)	диаметр трубки	количество /коробка	размер коробки (мм)
YPZ220/11-SS	11w	2700	E27	49	103	9	50	555*280*150
YPZ220/15-SS	15w	2700	E27	49	117	9	50	550*280*157
YPZ220/20-SS	20w	2700	E27	62	127	12	50	680*345*170
YPZ220/11-SS	11w	4000	E27	49	103	9	50	555*280*150
YPZ220/15-SS	15w	4000	E27	49	117	9	50	550*280*157
YPZ220/20-SS	20w	4000	E27	62	127	12	50	680*345*170
YPZ220/15-SS	15w	2700	E14	49	117	9	50	550*280*157

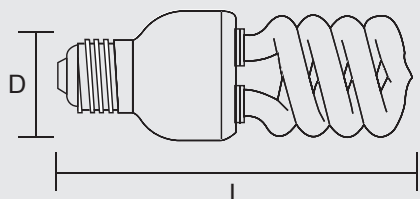

модель	мощность	цветовая температура	цоколь	D (мм)	L (мм)	диаметр трубки	количество /коробка	размер коробки (мм)
YPZ220/8-2S	8w	2700	E27	38	105	9	50	485*245*130
YPZ220/14-2S	14w	2700	E27	41	120	10	50	485*245*145
YPZ220/20-2S	20w	2700	E27	48,5	127	10	50	340*340*325
YPZ220/8-2S	8w	4000	E27	38	105	9	50	485*245*130
YPZ220/14-2S	14w	4000	E27	41	120	10	50	485*245*145
YPZ220/20-2S	20w	4000	E27	48,5	127	10	50	340*340*325

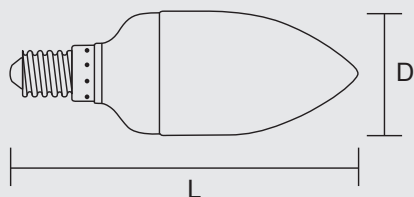

модель	мощность	цветовая температура	цоколь	D (мм)	L (мм)	количество /коробка	размер коробки (мм)
YPZ220/8-2SC	8w	4000	E14	38	108	50	440*225*139
YPZ220/8-2SC	8w	2700	E14	38	108	50	440*225*139

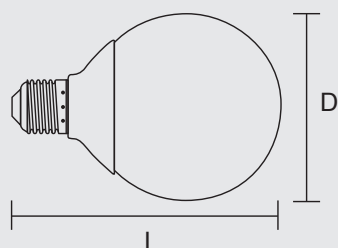

модель	мощность	цветовая температура	цоколь	D (мм)	L (мм)	количество /коробка	размер коробки (мм)
YPZ220/9-2SG	9w	2700	E27	60	109	50	650*330*139
YPZ220/15-2SG	15w	2700	E27	85	138	50	455*455*326
YPZ220/9-2SG	9w	4000	E27	60	109	50	650*330*139
YPZ220/15-2SG	15w	4000	E27	85	138	50	455*455*326
YPZ220/20-2SG	20w	2700	E27	105	145	50	560*560*340
YPZ220/20-2SG	20w	4000	E27	105	145	50	560*560*340
YPZ220/20-2SG	20w	6500	E27	105	145	50	560*560*340

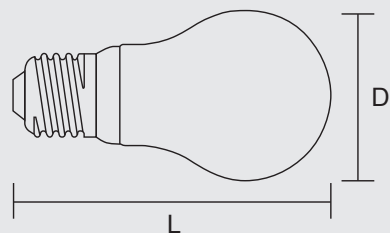

модель	мощность	цветовая температура	цоколь	D (мм)	L (мм)	количество /коробка	размер коробки (мм)
YPZ220/11-2SA	11W	4000	E27	39	94	50	600*305*156
YPZ220/20-2SA	20W	4000	E27	70	153	50	750*380*183

Энергосберегающие лампы

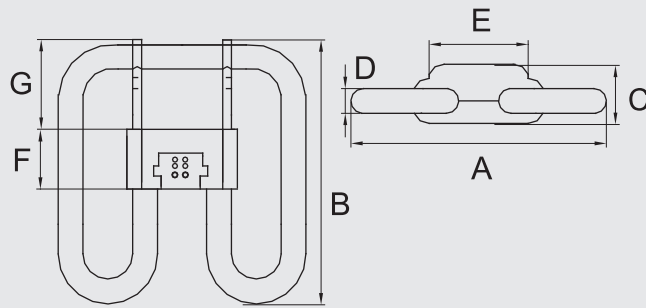

модель	мощность	цветовая температура	цоколь	A (мм)	B (мм)	C (мм)	D (мм)	E (мм)	F (мм)	G (мм)	количество /коробка	размер коробки (мм)
YD10W-2D	10w	4000~6500	2D	112	115	25	12,9-13,3	34	34	42	40	310*265*275
YD21W-2D	21w	4000~6500	2D	138	140	27,5	15	41	40	49	40	360*330*340
YD28W-2D	28w	4000~6500	2D	205	207	33	24	41	49	74	20	470*420*250
YD38W-2D	38w	4000~6500	2D	205	207	33	24	41	49/47	74	20	470*420*250

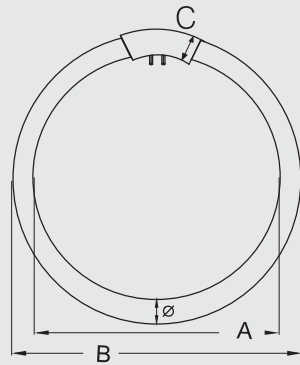

модель	мощность	цветовая температура	цоколь	A (мм)	B (мм)	C (мм)	количество /коробка	размер коробки (мм)
T5-GZ10q	22w	4000-6500	T5-GZ10q	153	185	16	50	705*405*205
T5-GZ10q	28w	4000-6500	T5-GZ10q	193	225	16	20	575*250*260
T5-GZ10q	38w	4000-6500	T5-GZ10q	267	299	16	20	575*325*335
T5-2GX13	60w	4000-6500	T5-2GX13	267	299	16	20	620*560*325

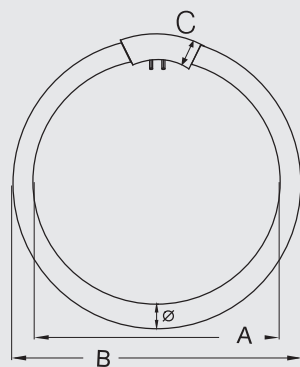

модель	мощность	цветовая температура	цоколь	A (мм)	B (мм)	C (мм)	количество /коробка	размер коробки (мм)
T6-GZ10q	40w	4000-6500	T6-GZ10q	240	280	21	50	690*590*305



ООО «Торговый Дом «Реал Керамика»

Оптовая продажа:

- интерьерное освещение
- керамическая плитка из Италии, Испании, Хорватии, Польши, России
- сантехника
- ванны чугунные, стальные, акриловые
- мебель для ванной комнаты
- смесители
- сифоны
- аксессуары

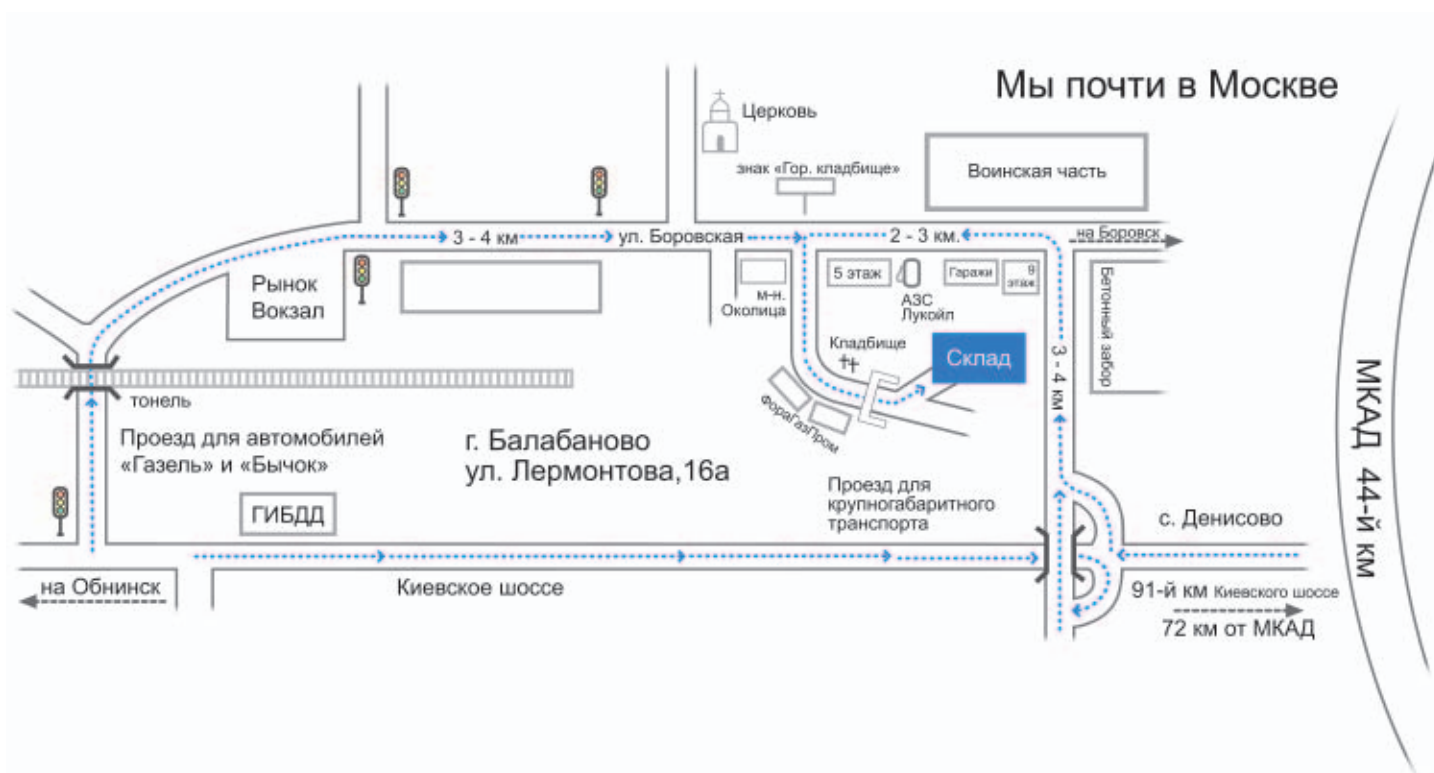

НАШИ КАТАЛОГИ



Каталог
«Интерьерное освещение 2013
Австрия, Испания»



Каталог
«Интерьерное освещение 2012
Австрия, Испания»



Каталог
«Интерьерное освещение 2012
Польша»



Каталог
«Плитка 2013»



Каталог
«Плитка 2012 НОВИНКИ»



Каталог
«Плитка 2012»



Каталог
«Сантехника 2012»



Каталог
«Продукция Lasko»



Брошюра
«Paffoni Fonte»



ООО «Торговый Дом «Реал Керамика»:
тел. +7 (495) 748-38-11
тел./факс (48439) 5-93-35 (многоканальный)

www.rkeramika.ru
e-mail: A.Sitnikov@rkeramika.ru

Склад:
г. Балабаново, ул. Лермонтова, 16А
график работы с 8.00 до 22.00

Розничный магазин:
249031, Калужская обл., г. Обнинск, ул. Победы, 16
тел. (48439) 5-75-54